

arma

okul donanımları





Biz Kimiz?

Ritim Park, sektördeki yerini kilometre taşlarımız olarak gördüğümüz başarılı projelerle ortaya koymuştur. Bu başarıya işinde uzmanlık, yüksek başarıyı hedefleme, yenilikçi ve yaratıcı anlayış, sürekli gelişim ilkeleriyle ulaşmıştır. Gerekli insan kaynağı, donanım ve teknik bilgiye sahip olup küresel anlamda kabul gören yöntemlerle işimizde farkımızı ortaya koyarız.

Kurumsal anlayış ve stratejimizi işimizin her safhasında göz önünde bulundururuz. Modern dünyanın gereklerini biliriz. Düşünmeye vakit ayırır, rutinleri sorgulayıp sıradanlaşmaktan kaçınılırız. Eleştiriye açık yapımızla öğrenen ve gelişen bir iş kültürünü oluşturmayı amaçlarız.

Başarımızın, müşteri başarısı ve memnuniyetiyle doğrudan ilişkili olduğunu kabul ederiz. Uzun vadeli, değer yaratan ilişkileri tercih edip müşteri ilişkilerimizi esneklik, güvenilirlik, hız ve çözüm ortaklığı üzerine kurmayı amaçlarız. Talepleri en doğru şekilde anlayan, iş ve hizmeti bu yönde tasarlayan, müşterisinde değer yaratan olmayı hedefleriz. Geniş ürün ve hizmet yelpazesıyla müşteri gereksinimlerini önceden gören, proaktif bir anlayışa sahibiz. Ana hedef kitlemiz olan çocuklarımızın kullanabileceği güvenilir, sağlıklı, eğlenceli, kültürel değerleri yansıtan çağdaş ürünler tasarlamayı sorumluluk kabul ederiz. Ayrıca çevreye karşı olan sorumluluğumuzun bilincinde olup bütün üretim ve iş süreçlerinde çevreye duyarlılık ana prensibimizdir. Ürünlerimizin ve hizmetlerimizin çevre ve sağlık dostu olmasına özen gösteririz. Ürünlerimiz ISO 9001:2008, ISO 14001:2004 OHSAS 18001:2007, TS EN 1176-1, TS EN 1176-2, TS EN 1176-3, TS EN 1176-4, TS EN 1176-5, TS EN 1176-6, TS EN 1176-11, TS 12427, TS EN 16630, TSEK belgeleri ile güvence altındadır.

Ritim Park has demonstrated its place in the sector with successful projects that we see as our milestones. This success has been achieved with the principles of expertise in its business, targeting overachievement, innovative and creative conception, and continuous development. We have the necessary human resources, fittings and technical knowledge and we demonstrate our difference in our business with globally accepted methods. We consider our corporate understanding and strategy at every stage of our business. We know the requirements of the modern world. We spare time for thinking. We avoid being ordinary by questioning routines. With our open structure to criticism, we aim at creating a learning and developing business culture. We recognize that our success is directly related to customer success and satisfaction. We prefer longterm, value-creating relationships and build our customer relationships on flexibility, reliability, speed and solution partnership. We aim to be the one who understands the demands in the most correct way, designs business and service in this direction, and creates value for the customer. With a wide range of products and services, we have a proactive understanding of anticipating customer needs. It is our responsibility to design modern products that are reliable, healthy, entertaining, reflecting cultural values that our main target group children can use. We are also aware of our responsibility towards the environment. Environmental sensitivity is our main principle in all production and business processes. We pay attention to produce healthy and environmentfriendly products. Our products are guaranteed with ISO 9001:2008, ISO 14001:2004 OHSAS 18001:2007, TS EN 1176-1, TS EN 1176-2, TS EN 1176-3, TS EN 1176-4, TS EN 1176-5, TS EN 1176-6, TS EN 1176-11, TS 12427, TS EN 16630, TSEK documents.

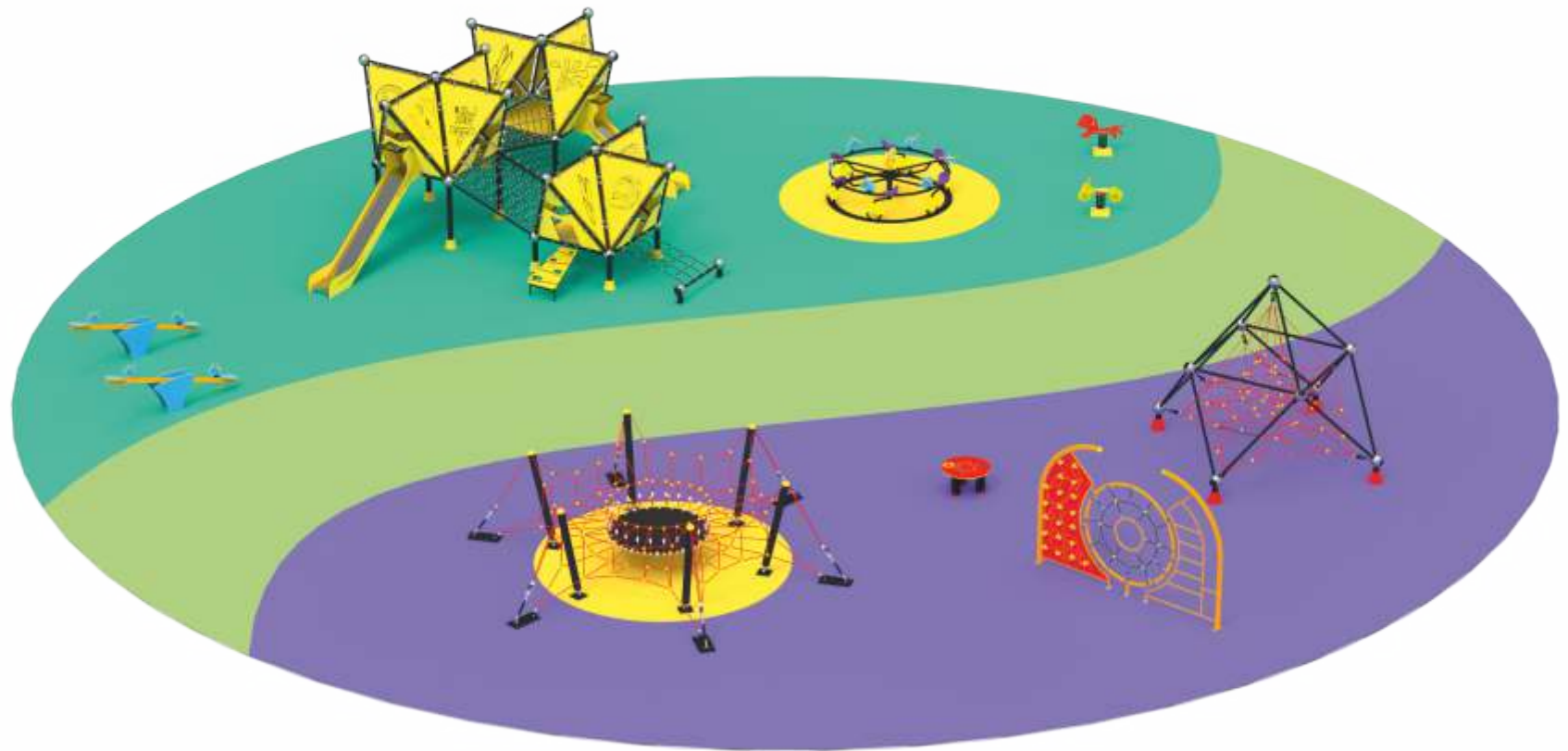



contents

İÇİNDEKİLER





AKSESUARLAR

115



KAUÇUK
ZEMİN

150



YEDEK
PARÇA

153



DIŞ MEKAN
SPOR ALETLERİ

134

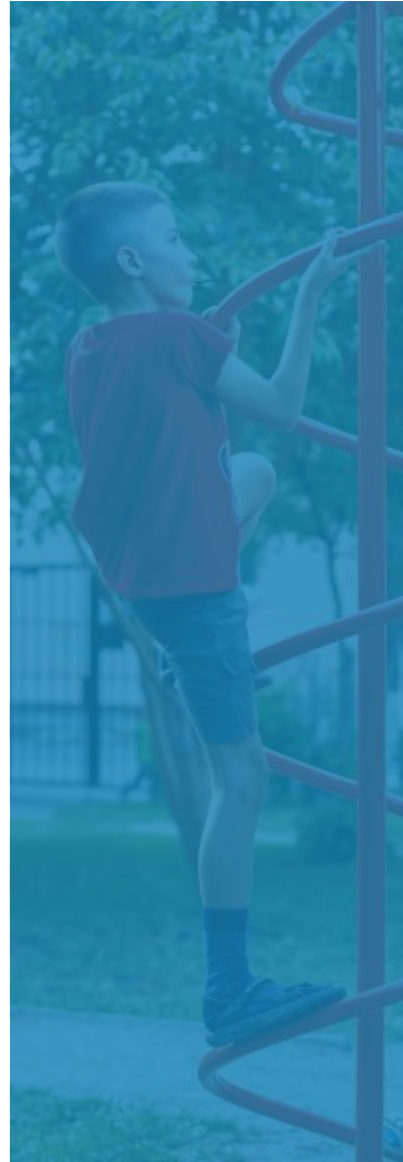

KENT
MOBİLYALARI

139



Yeni Nesil Oyun Grupları

New Generation Playgrounds

PN
01

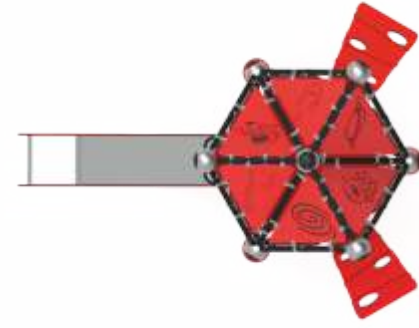

6.24 m
3.24 m

4.14 m Oturma Alanı / Sitting Area | _____
7.64 m Güvenlik Alanı / Safety Area | _____

PN
02

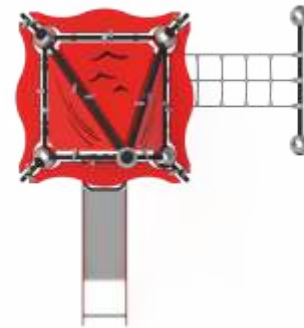

6.88 m
3.38 m

3.46 m Oturma Alanı / Sitting Area | _____
6.46 m Güvenlik Alanı / Safety Area | _____

PN
03

YAŞ GRUBU
Age

3+



Max
DÜŞME YÜKSEKLİĞİ
Fall Height

1m

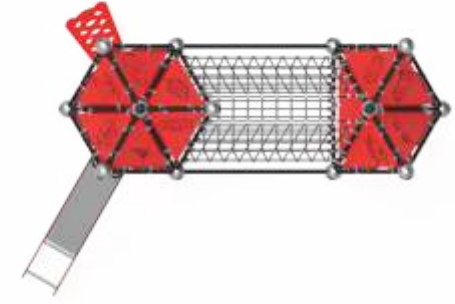

4.23 m
7.23 m

6.17 m Oturma Alanı / Sitting Area
9.17 m Güvenlik Alanı / Safety Area

PN
04

YAŞ GRUBU
Age

5+



Max
DÜŞME YÜKSEKLİĞİ
Fall Height

1.5m

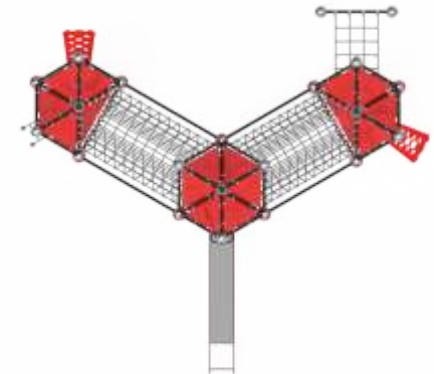

7.82 m
11.32 m

8.67 m Oturma Alanı / Sitting Area
11.67 m Güvenlik Alanı / Safety Area

PN
05

YAŞ GRUBU

Age

7+



Max

DÜŞME YÜKSEKLİĞİ

Fall Height

3m

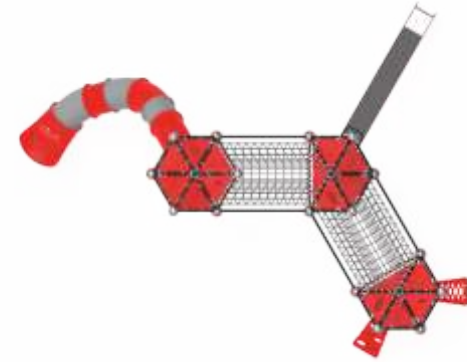

11.65 m
8.65 m

10.91 m Oturma Alanı / Sitting Area

13.91 m Güvenlik Alanı / Safety Area

PN
06

YAŞ GRUBU

Age

3+



Max

DÜŞME YÜKSEKLİĞİ

Fall Height

1m

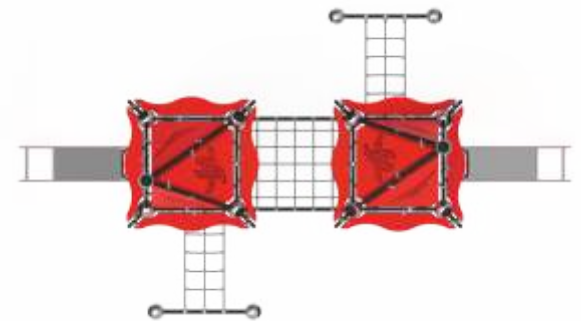

7.83 m
4.83 m

8.55 m Oturma Alanı / Sitting Area

12.55 m Güvenlik Alanı / Safety Area

PN
07

YAŞ GRUBU
Age

5+



Max
DÜŞME YÜKSEKLİĞİ
Fall Height

1,5m

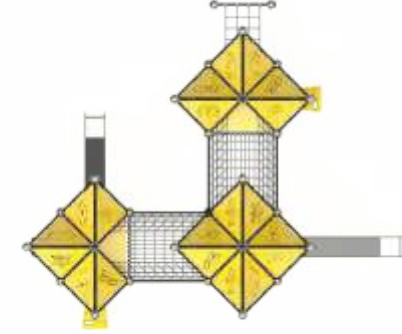

8.69 m

11.69 m

10.11 m Oturma Alanı / Sitting Area

13.61 m Güvenlik Alanı / Safety Area

PN
08

YAŞ GRUBU
Age

7+



Max
DÜŞME YÜKSEKLİĞİ
Fall Height

2,2m

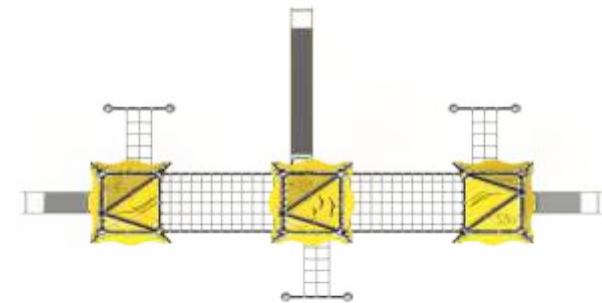

7.16 m

10.66 m

14.15 m Oturma Alanı / Sitting Area

18.15 m Güvenlik Alanı / Safety Area

PN
09

YAŞ GRUBU

Age

5+



Max
DÜŞME YÜKSEKLİĞİ

Fall Height

1.5m

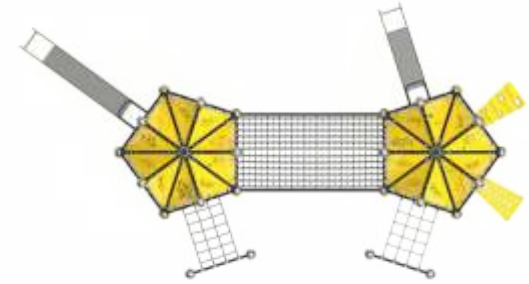

9.43 m
6.43 m

11.89 m Oturma Alanı / Sitting Area

14.89 m Güvenlik Alanı / Safety Area

PN
10

YAŞ GRUBU

Age

3+



Max
DÜŞME YÜKSEKLİĞİ

Fall Height

0.65m

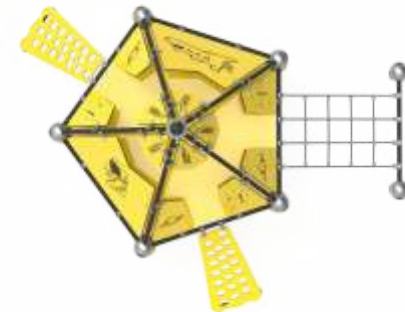

6.94 m
3.94 m

4.98 m Oturma Alanı / Sitting Area

7.98 m Güvenlik Alanı / Safety Area

PN
11

YAŞ GRUBU
Age

3+



Max
DÜŞME YÜKSEKLİĞİ
Fall Height

0.65m

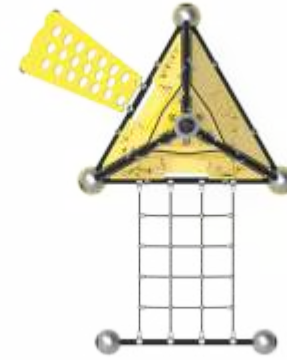

3.39 m

6.39 m

2.66 m Oturma Alanı / Sitting Area

5.66 m Güvenlik Alanı / Safety Area

PN
12

YAŞ GRUBU
Age

7+



Max
DÜŞME YÜKSEKLİĞİ
Fall Height

2.2m

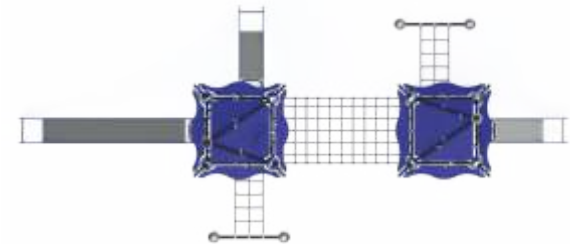

5.09 m

8.59 m

11.83m Oturma Alanı / Sitting Area

15.83 m Güvenlik Alanı / Safety Area

New Generation Playgrounds

PN
13

YAŞ GRUBU

Age

7+



Max
DÜŞME YÜKSEKLİĞİ

Fall Height

2.2m

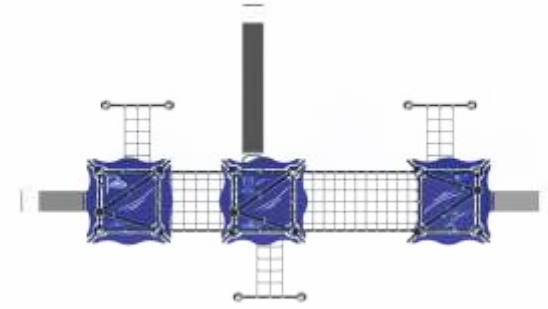
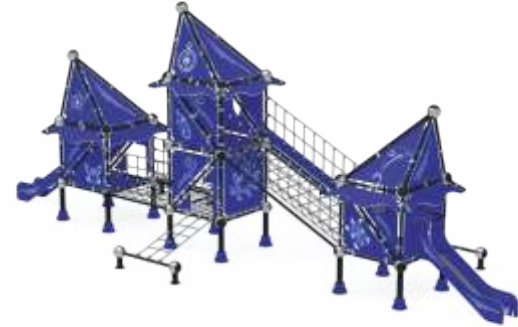

10.56 m
7.16 m

12.95 m Oturma Alanı / Sitting Area

16.95 m Güvenlik Alanı / Safety Area





Yeni Nesil Oyun Elemanları

New Generation Playground Equipments

PR
01

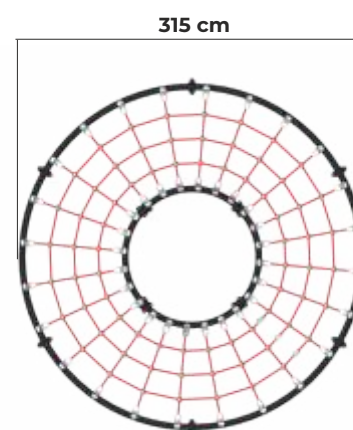
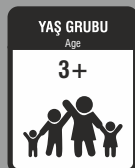

PR
02

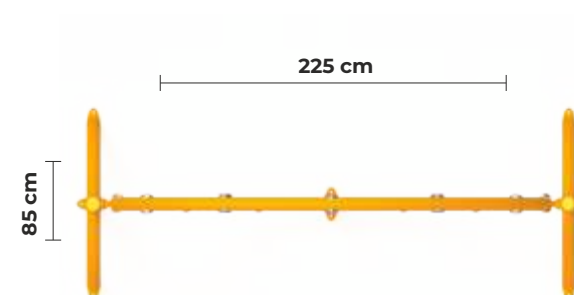
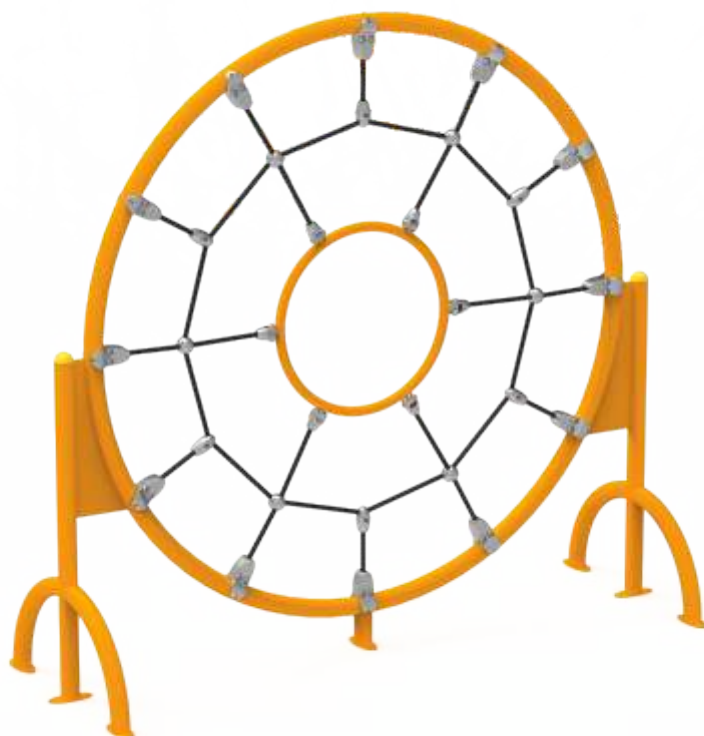

PR
03

YAŞ GRUBU

Age

5+



Max
DÜŞME YÜKSEKLİĞİ

Fall Height

2,7m

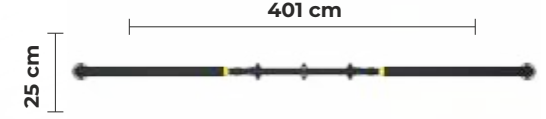
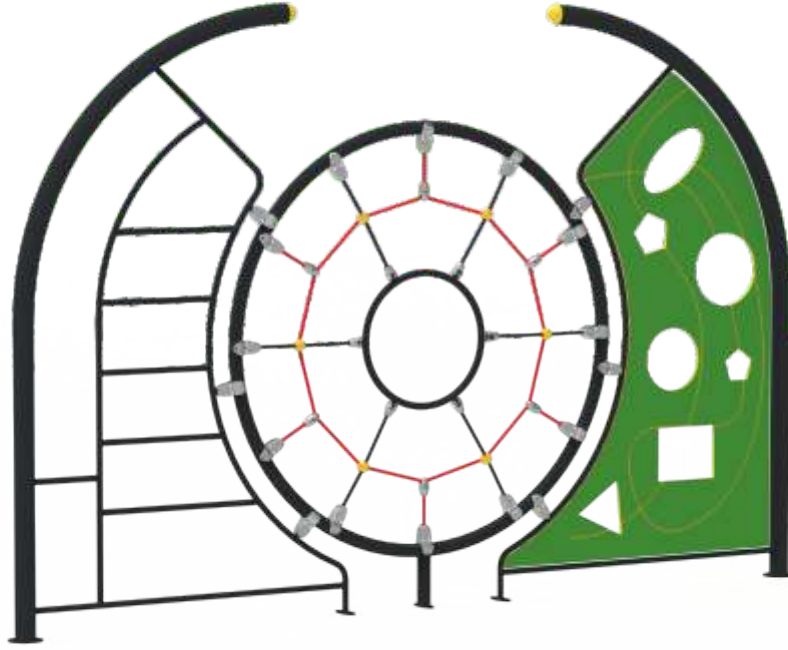

PR
04

YAŞ GRUBU

Age

5+



Max
DÜŞME YÜKSEKLİĞİ

Fall Height

2.2m

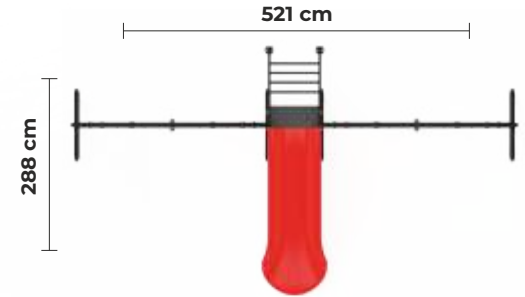

PR
05



257 cm

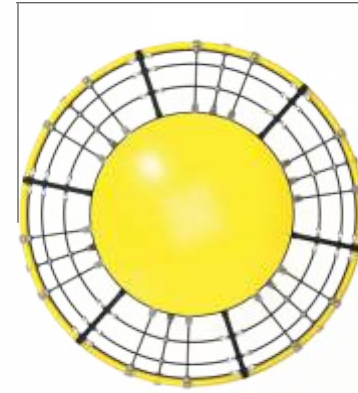

PR
06

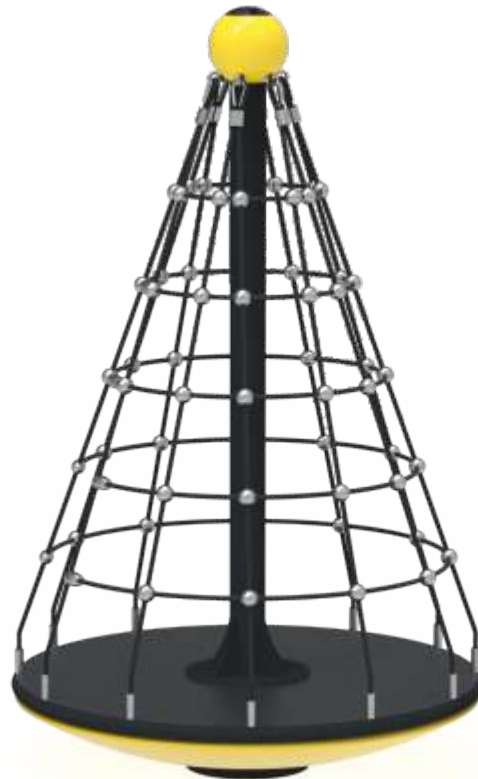

152 cm



PR
07



200 cm

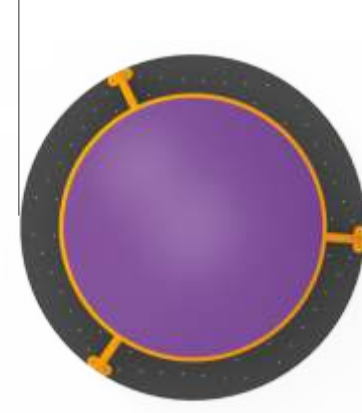

PR
08



198 cm

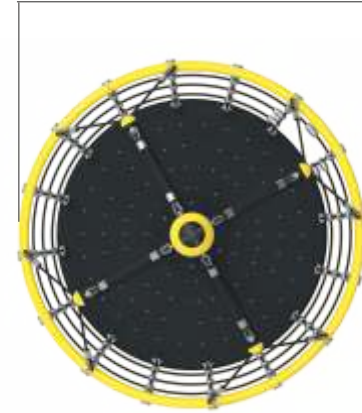

PR
09

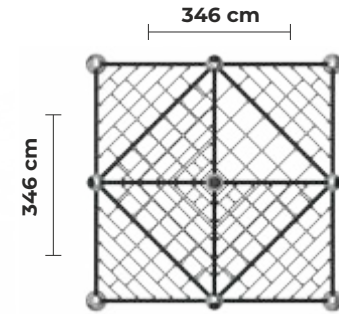
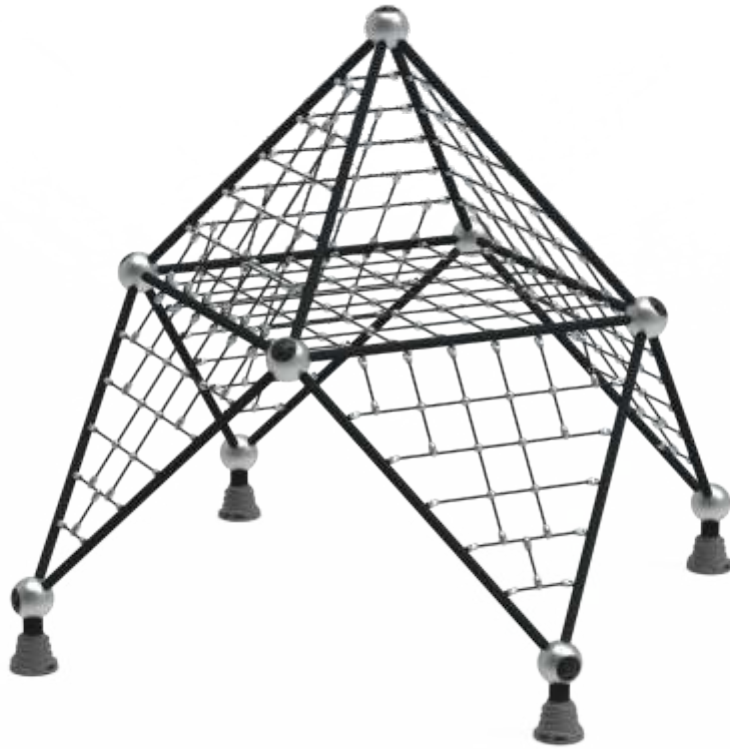

PR
10

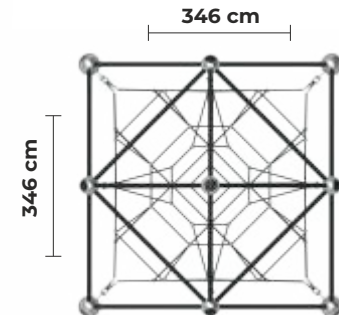
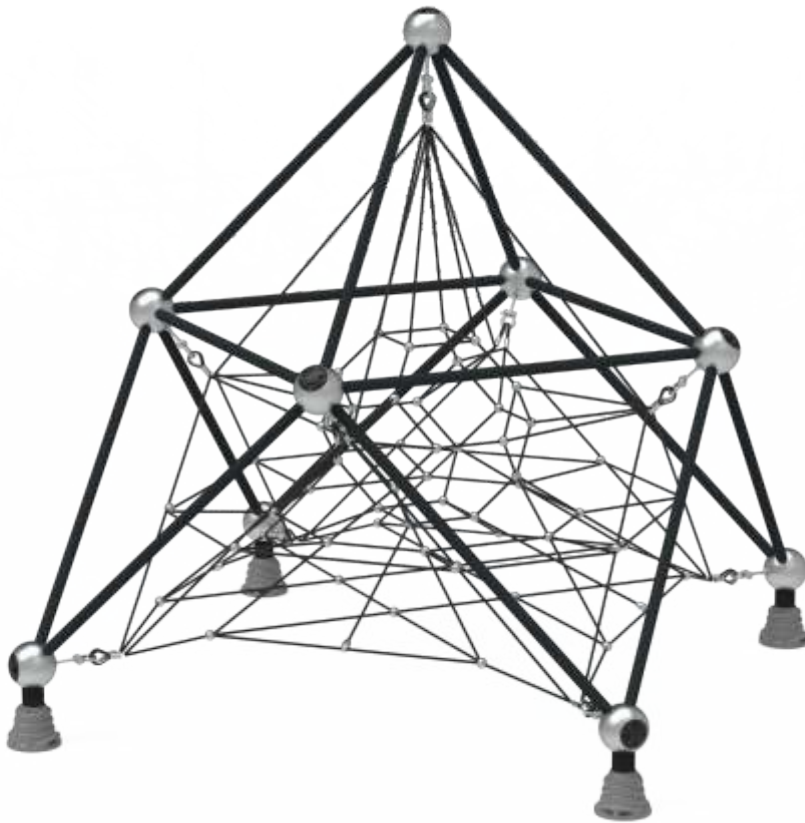

PR
11

YAŞ GRUBU

Age

5+



Max
DÜŞME YÜKSEKLİĞİ

Fall Height

2.4m

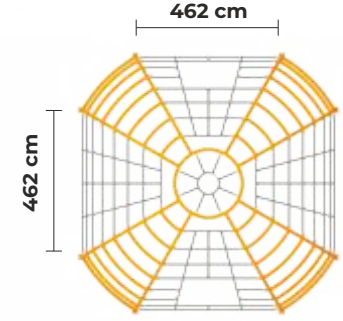
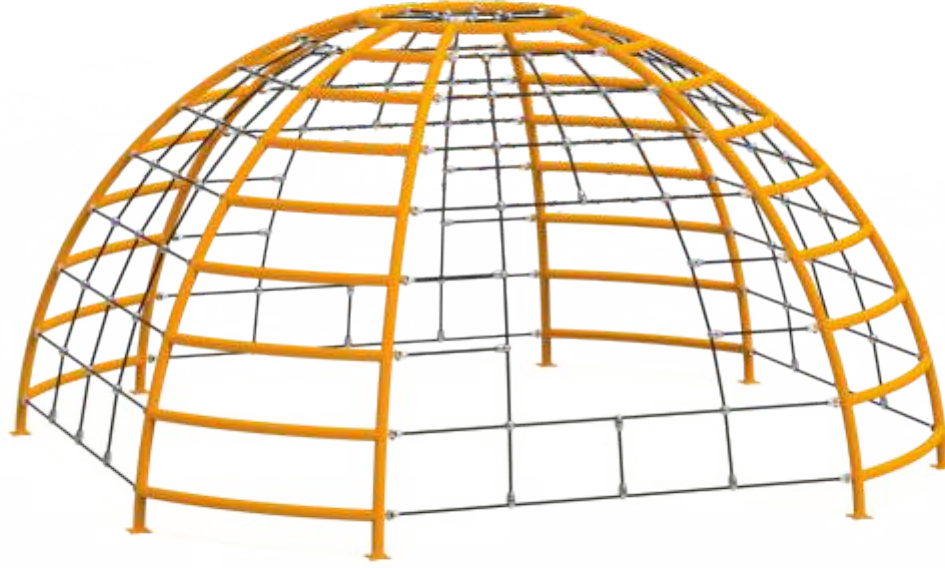

PR
12

YAŞ GRUBU

Age

5+



Max
DÜŞME YÜKSEKLİĞİ

Fall Height

2,1m

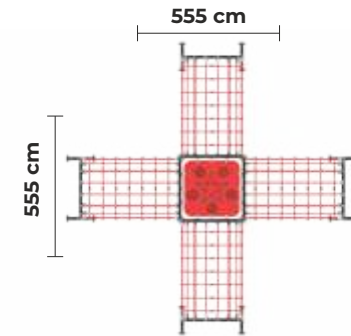

PR
13

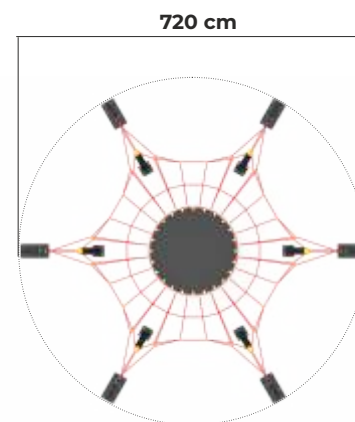
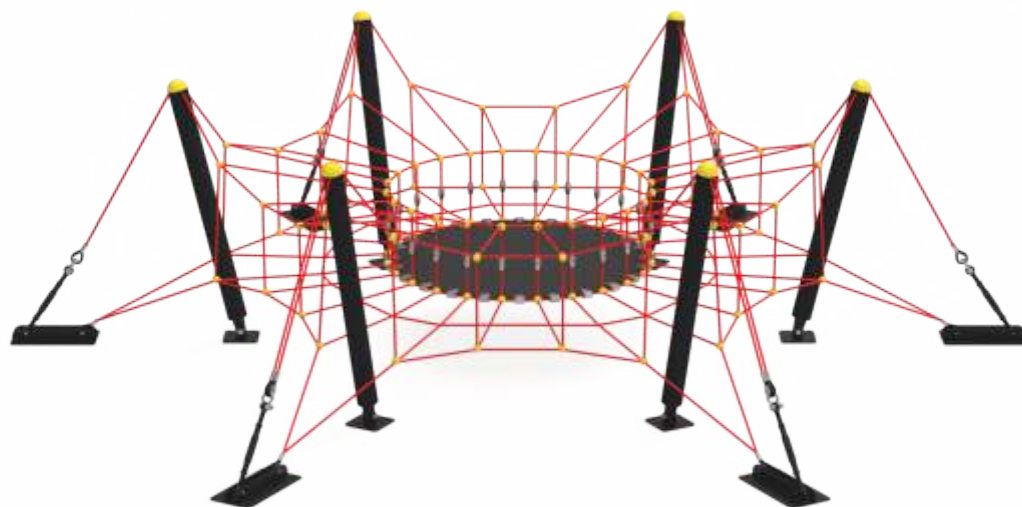
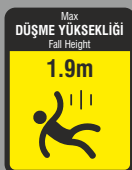

PR
14

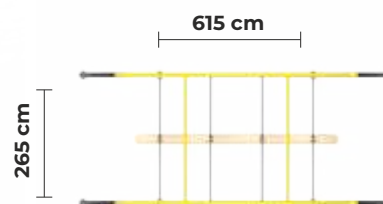
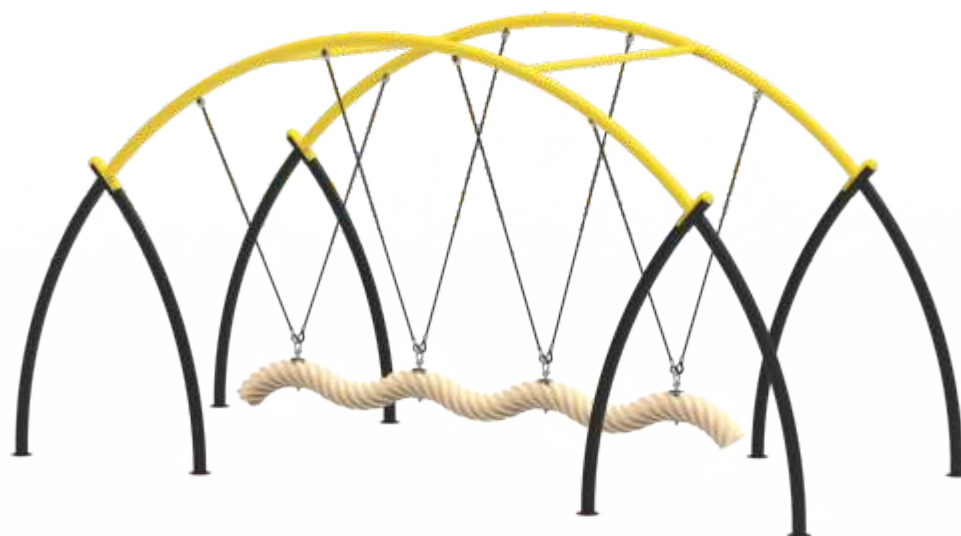

Yeni Nesil Oyun Elemanları

PR
15



259 cm



PR
16



228 cm

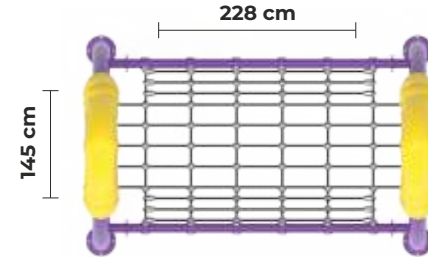

PR
17

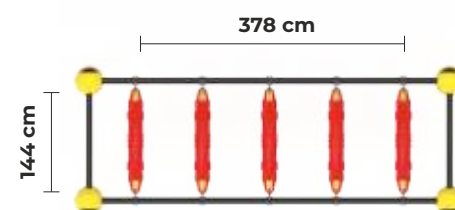
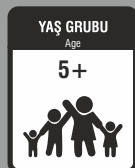

PR
18

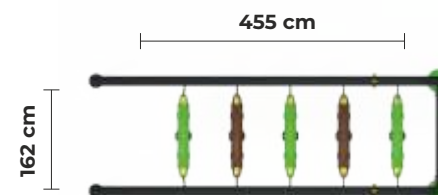
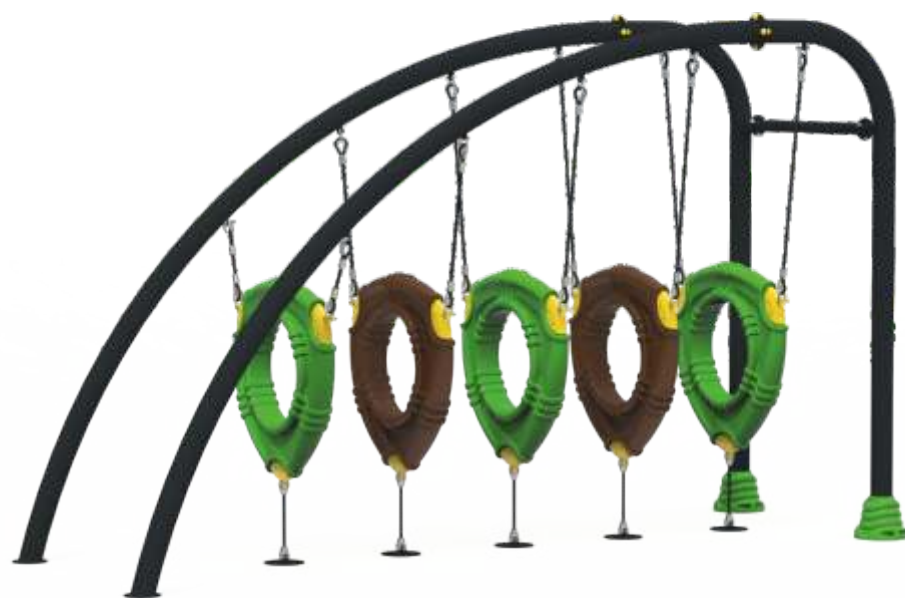
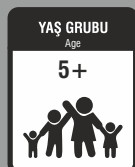

PR
19

YAŞ GRUBU

Age

5+



Max
DÜŞME YÜKSEKLİĞİ

Fall Height

2,9m

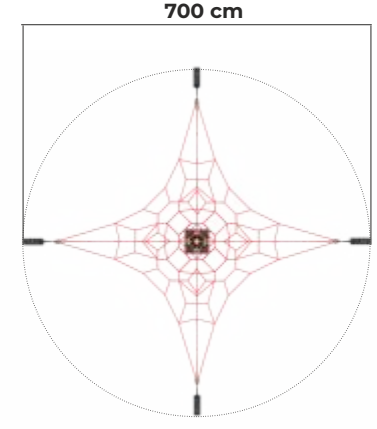
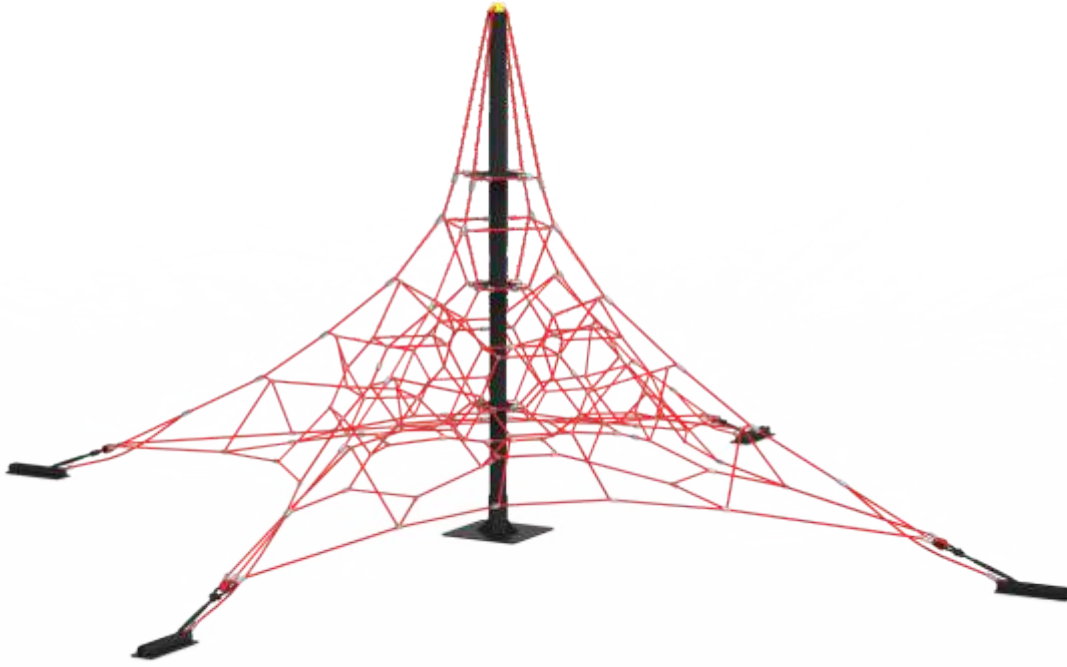

PR
20

YAŞ GRUBU

Age

5+



Max
DÜŞME YÜKSEKLİĞİ

Fall Height

2,8m

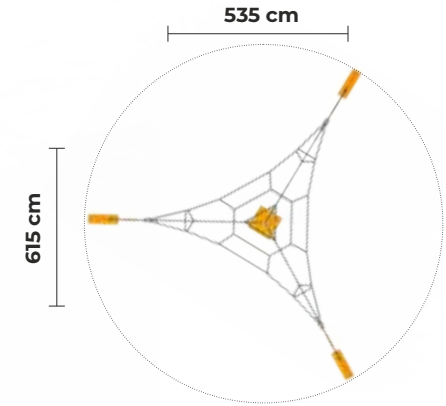
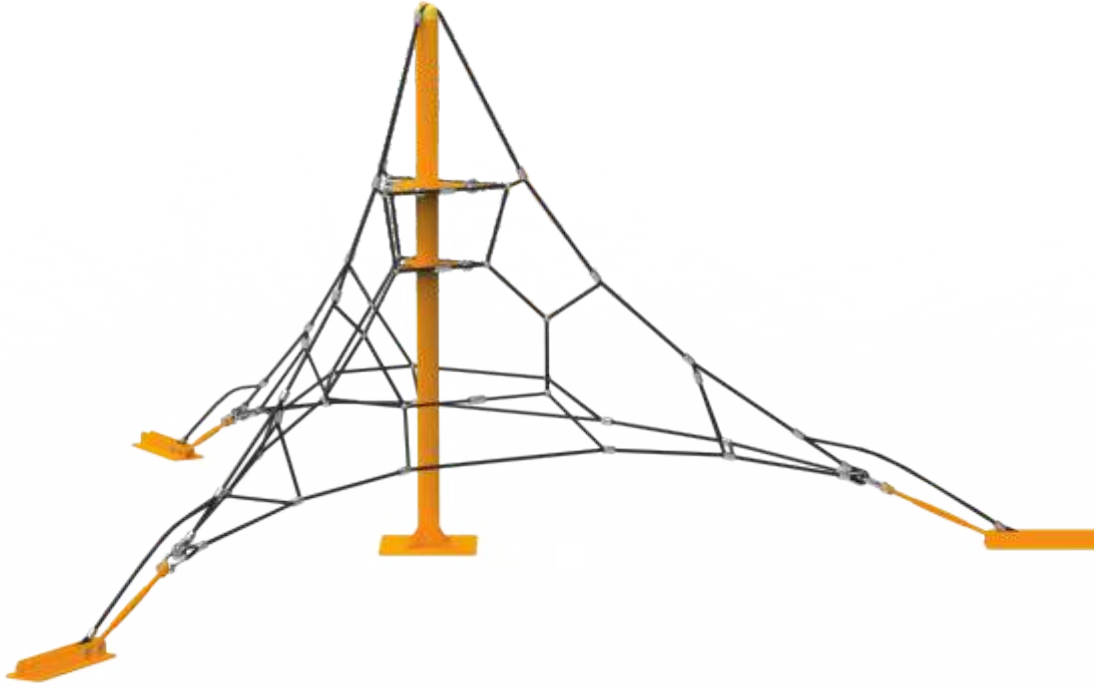

New Generation Playgrounds Equipments

PR
21

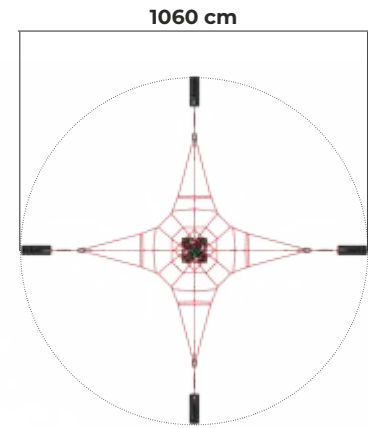
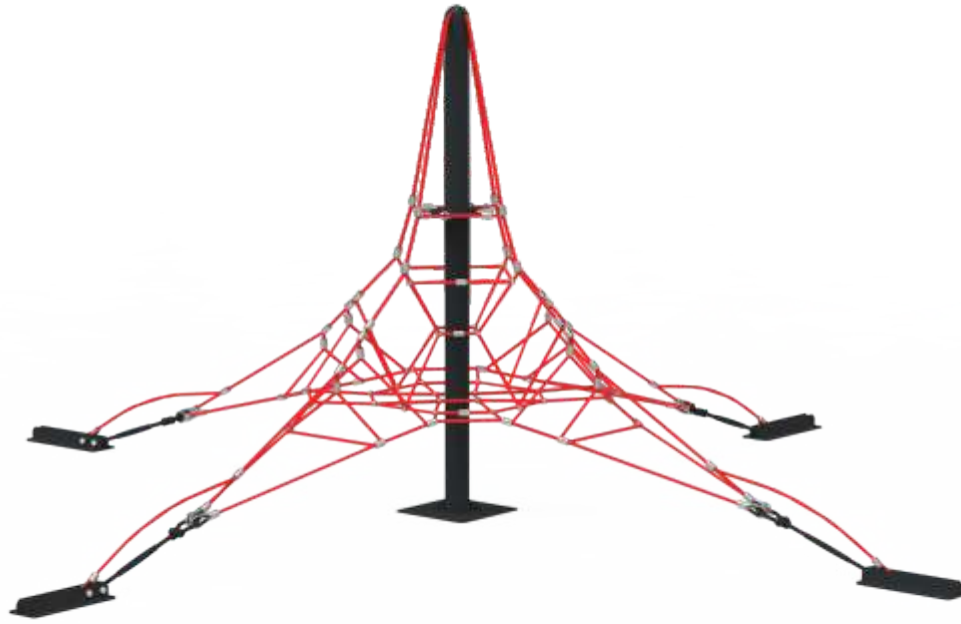

PR
22

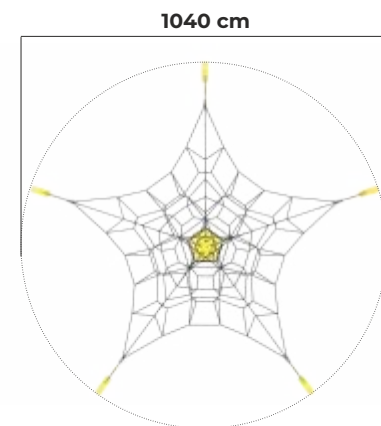
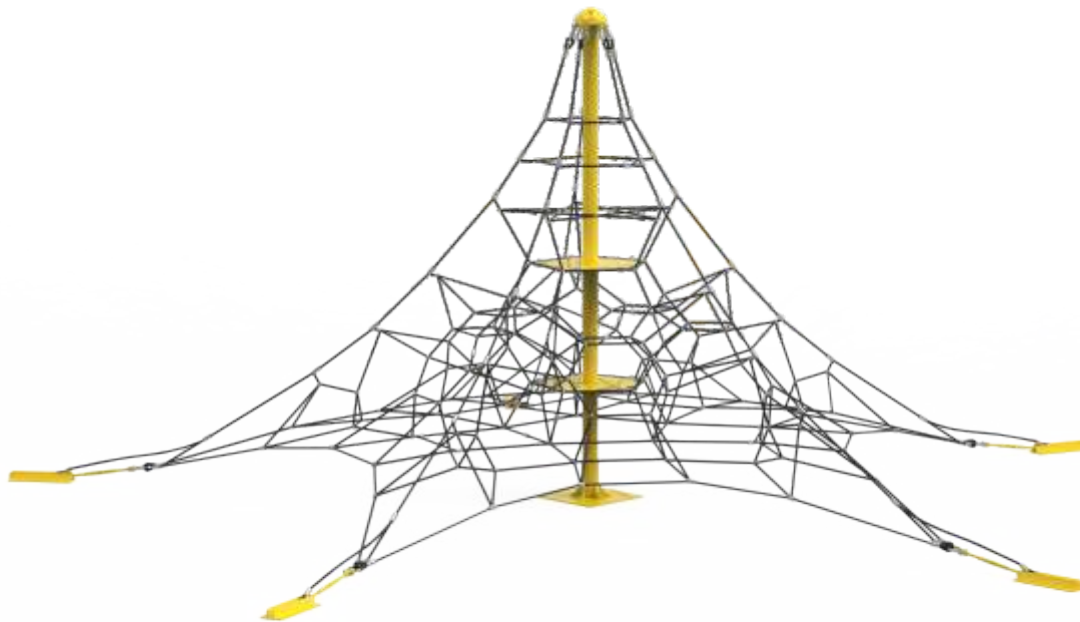

PR
23

YAŞ GRUBU

Age

5+



Max
DÜŞME YÜKSEKLİĞİ

Fall Height

2.71m

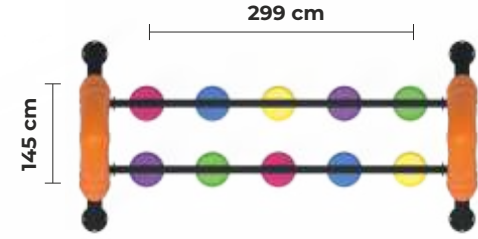

PR
24

YAŞ GRUBU

Age

5+



Max
DÜŞME YÜKSEKLİĞİ

Fall Height

2.56m

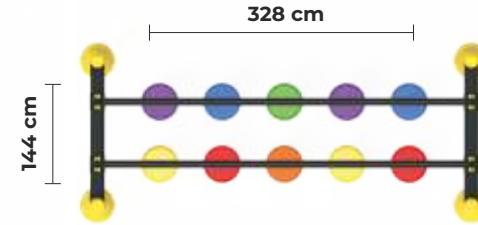

PR
25



407 cm



PR
26



189 cm

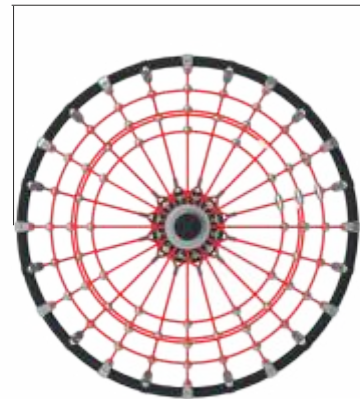

PR
27

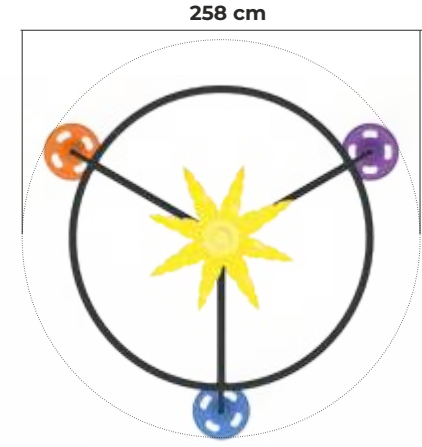
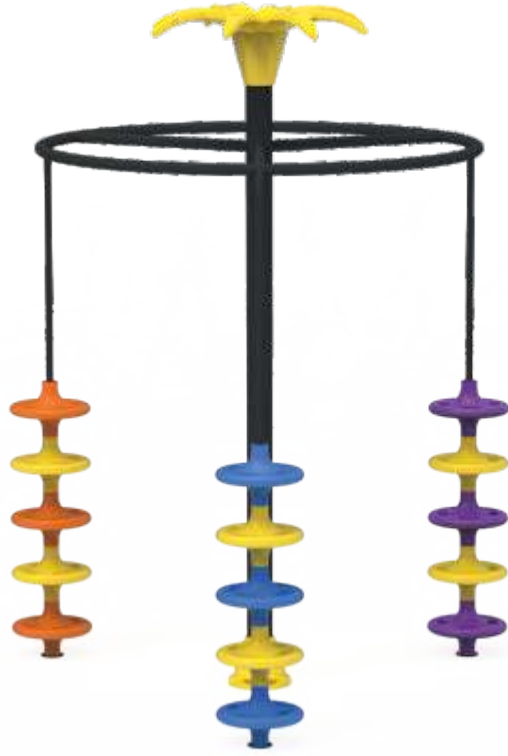

PR
28

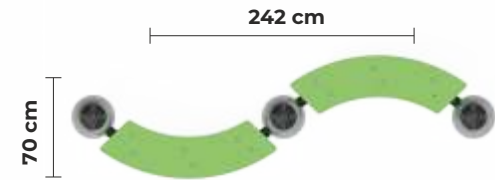

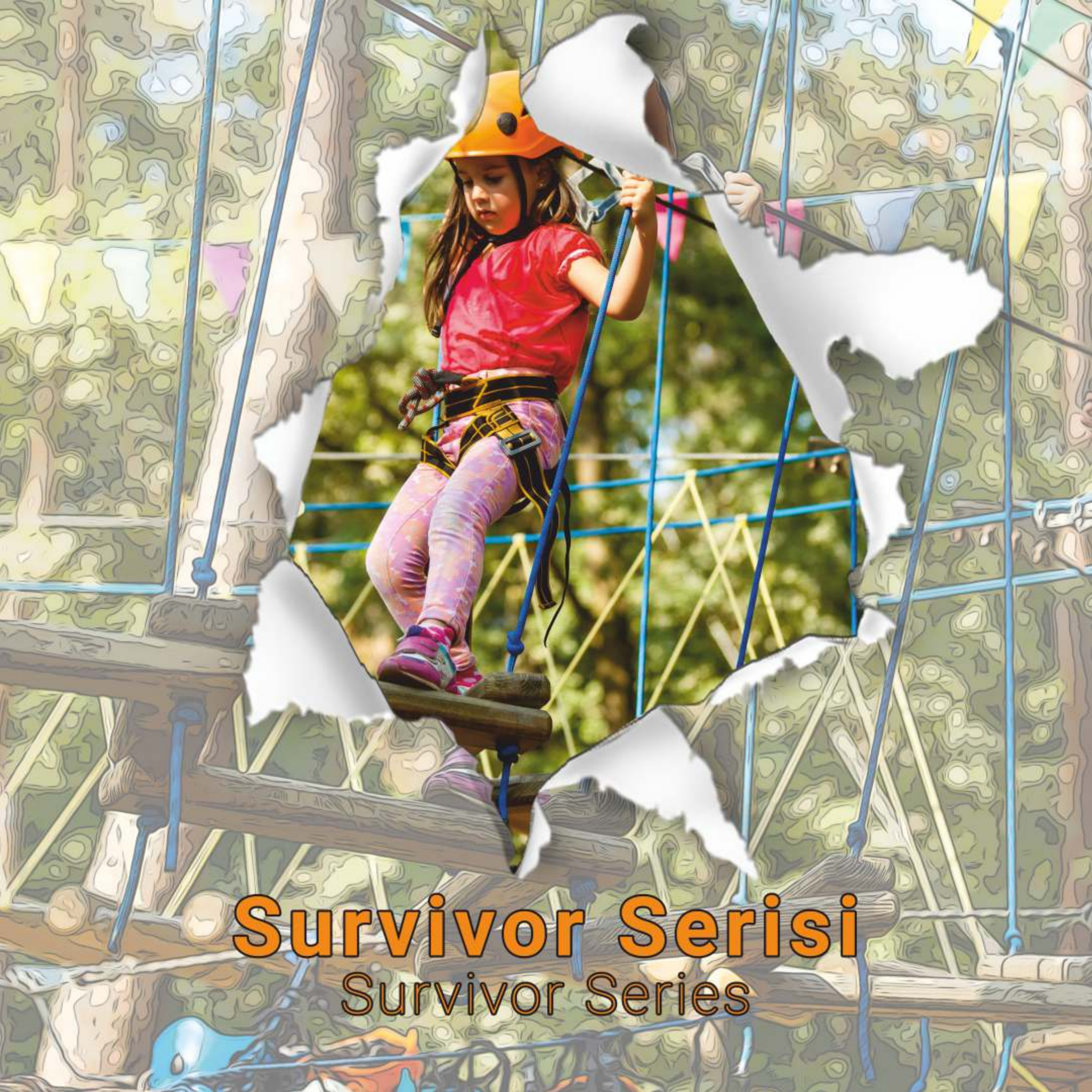

Survivor Serisi

Survivor Series

PS
01

YAŞ GRUBU

Age

3+



Max
DÜŞME YÜKSEKLİĞİ

Fall Height

2.20m

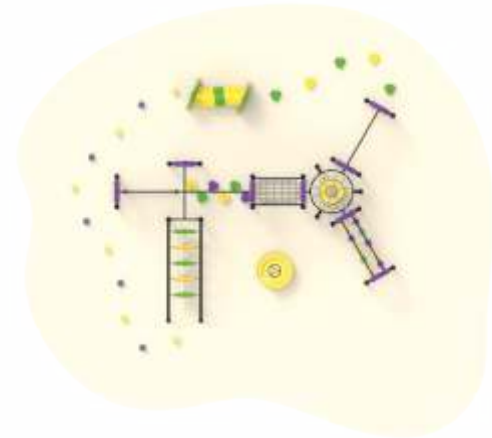

7.82 m

11.32 m

8.67 m Oturma Alanı / Sitting Area

11.67 m Güvenlik Alanı / Safety Area

PS
02

YAŞ GRUBU
Age

3+



Max
DÜŞME YÜKSEKLİĞİ
Fall Height

2.20m

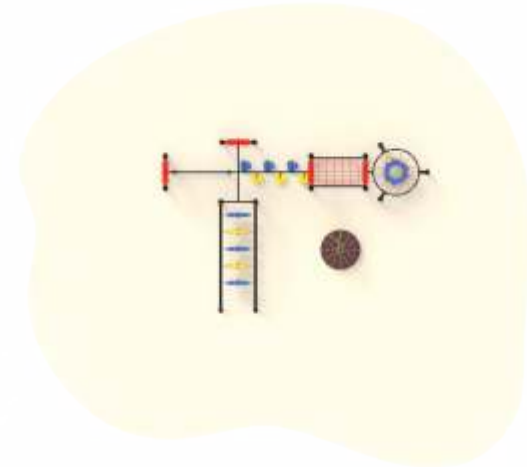

6.88 m
3.38 m

3.46 m Oturma Alanı / Sitting Area | _____
6.46 m Güvenlik Alanı / Safety Area | _____



Plastik Oyun Gruplari

Playground Sets

PT
01

YAŞ GRUBU

Age

3+



Max

DÜŞME YÜKSEKLİĞİ

Fall Height

1m



6.35 m
3.85 m

3 m Oturma Alanı / Sitting Area | _____

5 m Güvenlik Alanı / Safety Area | _____

PT
02

YAŞ GRUBU

Age

3+



Max

DÜŞME YÜKSEKLİĞİ

Fall Height

1m



7.10 m
4.60 m

1,50 m Oturma Alanı / Sitting Area | _____

3,50 m Güvenlik Alanı / Safety Area | _____

PT
03



4.50 m
7.00 m

1,60 m Oturma Alanı / Sitting Area
3.60 m Güvenlik Alanı / Safety Area

PT
04



3.70 m
5.90 m

2.40 m Oturma Alanı / Sitting Area
4.40 m Güvenlik Alanı / Safety Area

PT
05



6.50 m
4.00 m

2.05 m Oturma Alanı / Sitting Area
4.05 m Güvenlik Alanı / Safety Area

PT
06



6.50 m
4.00 m

2.05 m Oturma Alanı / Sitting Area
4.05 m Güvenlik Alanı / Safety Area

PT
07

YAŞ GRUBU

Age

3+



Max

DÜŞME YÜKSEKLİĞİ

Fall Height

1m



5.40 m

7.90 m

2.50 m Oturma Alanı / Sitting Area

4.50 m Güvenlik Alanı / Safety Area

PT
08

YAŞ GRUBU

Age

3+



Max

DÜŞME YÜKSEKLİĞİ

Fall Height

1m



4.50 m

7.00 m

6.30 m Oturma Alanı / Sitting Area

9.30 m Güvenlik Alanı / Safety Area

PT
09

YAŞ GRUBU

Age

3+



Max

DÜŞME YÜKSEKLİĞİ

Fall Height

1m



7.90 m
5.40 m

4.10 m Oturma Alanı / Sitting Area | _____
6.60 m Güvenlik Alanı / Safety Area | _____

PT
10

YAŞ GRUBU

Age

3+



Max

DÜŞME YÜKSEKLİĞİ

Fall Height

1m



7.90 m
5.40 m

4.10 m Oturma Alanı / Sitting Area | _____
6.60 m Güvenlik Alanı / Safety Area | _____

PT
11

YAŞ GRUBU
Age

3+



Max
DÜŞME YÜKSEKLİĞİ
Fall Height

1m



4.53 m

7.15 m

5.97 m Oturma Alanı / Sitting Area

7.97 m Güvenlik Alanı / Safety Area

PT
12

YAŞ GRUBU
Age

3+



Max
DÜŞME YÜKSEKLİĞİ
Fall Height

1.5m

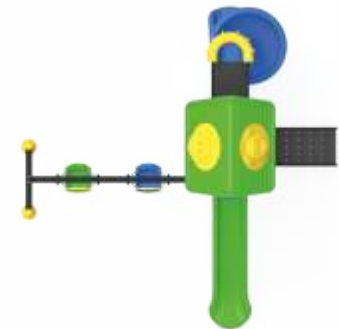

5.73 m

8.73 m

5.64 m Oturma Alanı / Sitting Area

7.64 m Güvenlik Alanı / Safety Area

PT
13



7.62 m
5.12 m

7.11 m Oturma Alanı / Sitting Area | _____
9.61 m Güvenlik Alanı / Safety Area | _____

PT
14

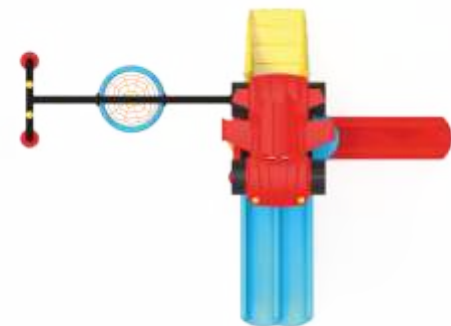

7.29 m
4.79 m

9.46 m Oturma Alanı / Sitting Area | _____
8.96 m Güvenlik Alanı / Safety Area | _____

PT
15

YAŞ GRUBU
Age

3+



Max
DÜŞME YÜKSEKLİĞİ
Fall Height

1m



4.46 m

6.96 m

6.55 m Oturma Alanı / Sitting Area

9.05 m Güvenlik Alanı / Safety Area

PT
16

YAŞ GRUBU
Age

3+



Max
DÜŞME YÜKSEKLİĞİ
Fall Height

1m



4.93 m

7.43 m

6.33 m Oturma Alanı / Sitting Area

8.33 m Güvenlik Alanı / Safety Area

PT
17

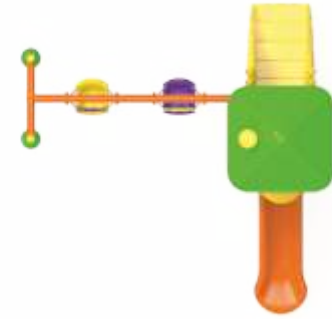

6.96 m
4.46 m

4.49 m Oturma Alanı / Sitting Area | _____
6.49 m Güvenlik Alanı / Safety Area | _____

PT
18

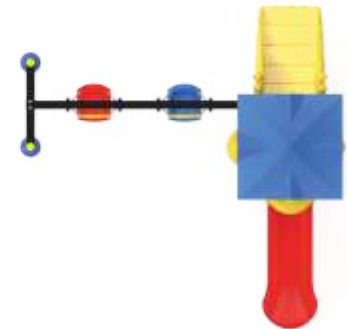

6.96 m
4.46 m

4.50 m Oturma Alanı / Sitting Area | _____
6.50 m Güvenlik Alanı / Safety Area | _____

PT
19

YAŞ GRUBU
Age

3+



Max
DÜŞME YÜKSEKLİĞİ
Fall Height

1m



4.44 m Oturma Alanı / Sitting Area | _____
6.44 m Güvenlik Alanı / Safety Area | _____

4.46 m
6.96 m

PT
20

YAŞ GRUBU
Age

3+



Max
DÜŞME YÜKSEKLİĞİ
Fall Height

1m



4.44 m Oturma Alanı / Sitting Area | _____
6.44 m Güvenlik Alanı / Safety Area | _____

4.77 m
7.27 m

PT
21



7.27 m
4.77 m

7.17 m Oturma Alanı / Sitting Area | _____
9.17 m Güvenlik Alanı / Safety Area | _____

PT
22

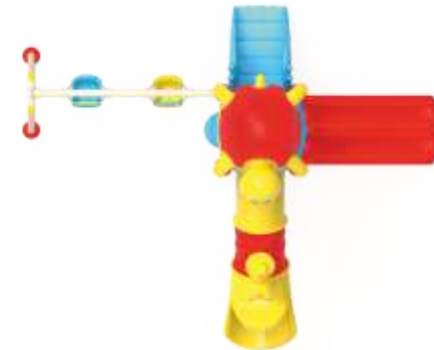

7.89 m
5.39 m

6.55 m Oturma Alanı / Sitting Area | _____
9.05 m Güvenlik Alanı / Safety Area | _____

PT
23

YAŞ GRUBU
Age

3+



Max
DÜŞME YÜKSEKLİĞİ
Fall Height

1m



4.46 m
6.96 m

6.00m Oturma Alanı / Sitting Area

8.50 m Güvenlik Alanı / Safety Area

PT
24

YAŞ GRUBU
Age

3+



Max
DÜŞME YÜKSEKLİĞİ
Fall Height

1.5m

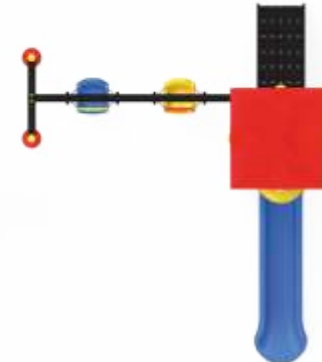

5.19 m
7.69 m

4.50 m Oturma Alanı / Sitting Area

6.50 m Güvenlik Alanı / Safety Area

PT
25

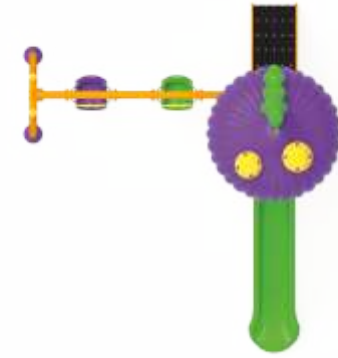

7.69 m
5.19 m

4.68 m Oturma Alanı / Sitting Area | _____
6.68 m Güvenlik Alanı / Safety Area | _____

PT
26



8.75 m
6.25 m

6.91 m Oturma Alanı / Sitting Area | _____
9.41 m Güvenlik Alanı / Safety Area | _____

PT
27

YAŞ GRUBU
Age

3+



Max
DÜŞME YÜKSEKLİĞİ
Fall Height

1.5m



6.25 m

8.75 m

4.54 m Oturma Alanı / Sitting Area

6.54 m Güvenlik Alanı / Safety Area

PT
28

YAŞ GRUBU
Age

3+



Max
DÜŞME YÜKSEKLİĞİ
Fall Height

1.5m

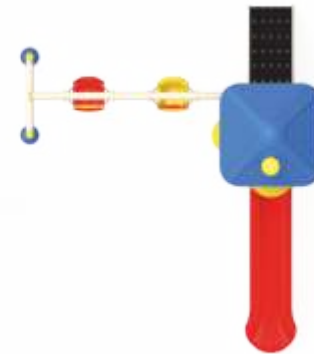

5.19 m

7.69 m

4.60 m Oturma Alanı / Sitting Area

6.60 m Güvenlik Alanı / Safety Area

PT
29

YAŞ GRUBU

Age

3+



Max

DÜŞME YÜKSEKLİĞİ

Fall Height

1.5m

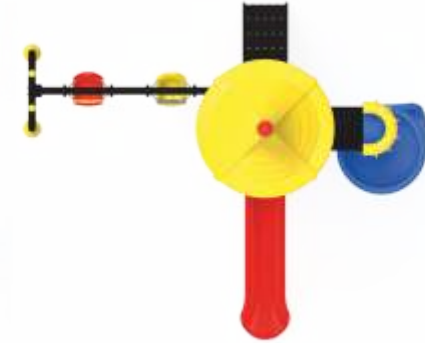

6.15 m Oturma Alanı / Sitting Area

8.65 m Güvenlik Alanı / Safety Area

7.69 m
5.19 m

PT
30

YAŞ GRUBU

Age

3+



Max

DÜŞME YÜKSEKLİĞİ

Fall Height

1.5m



6.15 m Oturma Alanı / Sitting Area

8.65 m Güvenlik Alanı / Safety Area

7.69 m
5.19 m

PT
31

YAŞ GRUBU
Age

3+



Max
DÜŞME YÜKSEKLİĞİ
Fall Height

1.5m

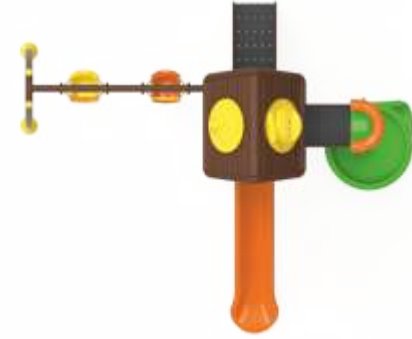

5.19 m

7.69 m

6.15 m Oturma Alanı / Sitting Area

8.65 m Güvenlik Alanı / Safety Area

PT
32

YAŞ GRUBU
Age

3+



Max
DÜŞME YÜKSEKLİĞİ
Fall Height

1.5m



5.19 m

7.69 m

6.21 m Oturma Alanı / Sitting Area

8.71 m Güvenlik Alanı / Safety Area

PT
33

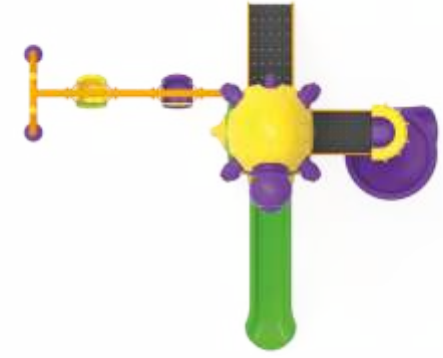

7.69 m
5.19 m

6.15m Oturma Alanı / Sitting Area | _____
8.65 m Güvenlik Alanı / Safety Area | _____

PT
34



7.69 m
5.19 m

6.21 m Oturma Alanı / Sitting Area | _____
8.71 m Güvenlik Alanı / Safety Area | _____

PT
35



6.25 m

8.75 m

6.15 m Oturma Alanı / Sitting Area

8.65 m Güvenlik Alanı / Safety Area

PT
36



5.19 m

7.69 m

6.21 m Oturma Alanı / Sitting Area

8.71 m Güvenlik Alanı / Safety Area

PT
37

YAŞ GRUBU
Age

3+



Max
DÜŞME YÜKSEKLİĞİ
Fall Height

1.5m



8.75 m
6.25 m

6.15 m Oturma Alanı / Sitting Area

8.65 m Güvenlik Alanı / Safety Area

PT
38

YAŞ GRUBU
Age

3+



Max
DÜŞME YÜKSEKLİĞİ
Fall Height

1.5m



7.69 m
5.19 m

6.21 m Oturma Alanı / Sitting Area

8.71 m Güvenlik Alanı / Safety Area

PT
39

YAŞ GRUBU
Age

3+



Max
DÜŞME YÜKSEKLİĞİ
Fall Height

1.5m



7.42 m
9.92 m

6.23 m Oturma Alanı / Sitting Area

8.73 m Güvenlik Alanı / Safety Area

PT
40

YAŞ GRUBU
Age

3+



Max
DÜŞME YÜKSEKLİĞİ
Fall Height

1m



5.39 m
7.89 m

6.91 m Oturma Alanı / Sitting Area

8.91 m Güvenlik Alanı / Safety Area

PT
41



6.40 m
3.90 m

7.35 m Oturma Alanı / Sitting Area
9.85 m Güvenlik Alanı / Safety Area

PT
42

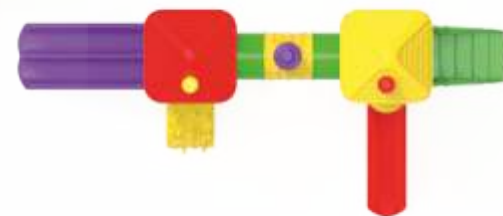

5.90 m
3.40 m

8.00 m Oturma Alanı / Sitting Area
10.50 m Güvenlik Alanı / Safety Area

PT
43

YAŞ GRUBU
Age

3+



Max
DÜŞME YÜKSEKLİĞİ
Fall Height

1.5m



4.39 m

6.89 m

6.26 m Oturma Alanı / Sitting Area

8.76 m Güvenlik Alanı / Safety Area

PT
44

YAŞ GRUBU
Age

3+



Max
DÜŞME YÜKSEKLİĞİ
Fall Height

2m

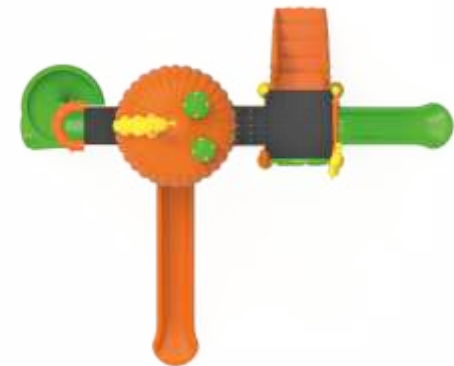

5.89 m

8.39 m

7.12 m Oturma Alanı / Sitting Area

10.12 m Güvenlik Alanı / Safety Area

PT
45

YAŞ GRUBU
Age

3+



Max
DÜŞME YÜKSEKLİĞİ
Fall Height

1m



7.90 m
5.40 m

7.40 m Oturma Alanı / Sitting Area | _____

9.90 m Güvenlik Alanı / Safety Area | _____

PT
46

YAŞ GRUBU
Age

3+



Max
DÜŞME YÜKSEKLİĞİ
Fall Height

1m



7.27 m
4.77 m

9.20 m Oturma Alanı / Sitting Area | _____

12.20 m Güvenlik Alanı / Safety Area | _____

PT
47



4.55 m Oturma Alanı / Sitting Area
6.67 m Güvenlik Alanı / Safety Area

4.52 m
6.52 m

PT
48



4.82 m Oturma Alanı / Sitting Area
7.32 m Güvenlik Alanı / Safety Area

5.80 m
8.30 m

PT
49



9.69 m
6.69 m

5.14 m Oturma Alanı / Sitting Area | _____
7.64 m Güvenlik Alanı / Safety Area | _____

PT
50

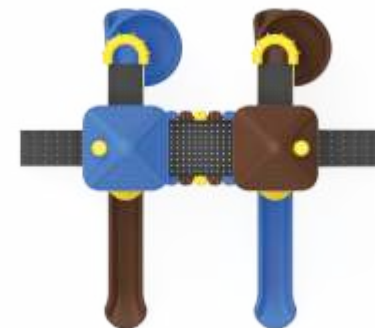

8.73 m
5.73 m

6.50 m Oturma Alanı / Sitting Area | _____
8.50 m Güvenlik Alanı / Safety Area | _____

PT
51

YAŞ GRUBU
Age

3+



Max
DÜŞME YÜKSEKLİĞİ
Fall Height

1.5m

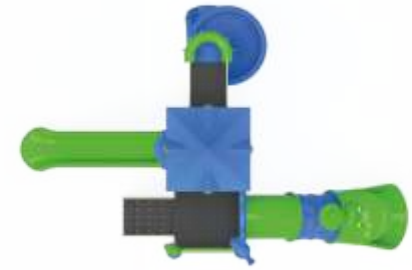

4.50 m

7.50 m

6.69 m Oturma Alanı / Sitting Area

9.69 m Güvenlik Alanı / Safety Area

PT
52

YAŞ GRUBU
Age

3+



Max
DÜŞME YÜKSEKLİĞİ
Fall Height

1.5m



5.9 m

7.66 m

11.87 m Oturma Alanı / Sitting Area

14.87 m Güvenlik Alanı / Safety Area

PT
53

YAŞ GRUBU
Age

3+



Max
DÜŞME YÜKSEKLİĞİ
Fall Height

1m

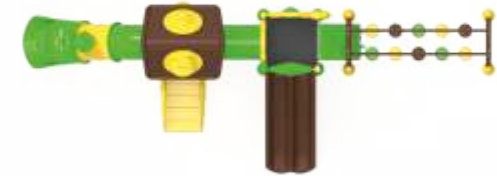

6.21 m
3.71 m

10.15 m Oturma Alanı / Sitting Area

12.65 m Güvenlik Alanı / Safety Area

PT
54

YAŞ GRUBU
Age

3+



Max
DÜŞME YÜKSEKLİĞİ
Fall Height

1.5m



8.76 m
6.26 m

7.98 m Oturma Alanı / Sitting Area

10.48 m Güvenlik Alanı / Safety Area

PT
55

YAŞ GRUBU

Age

3+



Max

DÜŞME YÜKSEKLİĞİ

Fall Height

1.5m



5.38 m

7.88 m

9.21 m Oturma Alanı / Sitting Area

11.21 m Güvenlik Alanı / Safety Area

PT
56

YAŞ GRUBU

Age

3+



Max

DÜŞME YÜKSEKLİĞİ

Fall Height

1.5m



6.26 m

8.76 m

7.98 m Oturma Alanı / Sitting Area

10.48 m Güvenlik Alanı / Safety Area

PT
57

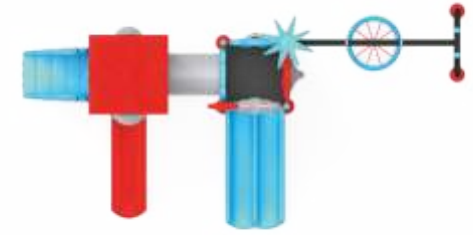

6.65 m
4.15 m

8.10 m Oturma Alanı / Sitting Area | _____
10.10 m Güvenlik Alanı / Safety Area | _____

PT
58



6.96 m
4.46 m

7.32 m Oturma Alanı / Sitting Area | _____
9.82 m Güvenlik Alanı / Safety Area | _____

PT
59

YAŞ GRUBU

Age

3+



Max
DÜŞME YÜKSEKLİĞİ

Fall Height

1.5m



5.19 m

7.69 m

7.32 m Oturma Alanı / Sitting Area

9.82 m Güvenlik Alanı / Safety Area

PT
60

YAŞ GRUBU

Age

3+



Max
DÜŞME YÜKSEKLİĞİ

Fall Height

1.5m



6.75 m

9.25 m

6.26 m Oturma Alanı / Sitting Area

8.76 m Güvenlik Alanı / Safety Area

PT
61

YAŞ GRUBU

Age

3+



Max
DÜŞME YÜKSEKLİĞİ

Fall Height

1.5m



7.89 m

8.82 m Oturma Alanı / Sitting Area

11.32 m Güvenlik Alanı / Safety Area

PT
62

YAŞ GRUBU

Age

3+



Max
DÜŞME YÜKSEKLİĞİ

Fall Height

1.5m



10.48 m

5.80 m Oturma Alanı / Sitting Area

8.30 m Güvenlik Alanı / Safety Area

PT
63

YAŞ GRUBU
Age

3+



Max
DÜŞME YÜKSEKLİĞİ
Fall Height

2m



5.40 m
7.90 m

4.10 m Oturma Alanı / Sitting Area

6.60 m Güvenlik Alanı / Safety Area

PT
64

YAŞ GRUBU
Age

5+



Max
DÜŞME YÜKSEKLİĞİ
Fall Height

2m

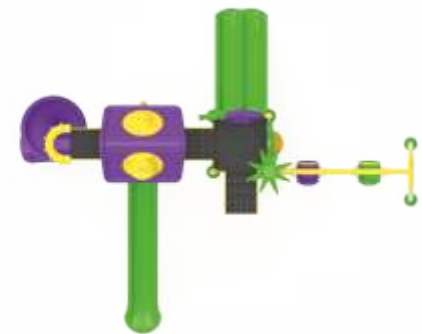

6.78 m
9.78 m

8.27 m Oturma Alanı / Sitting Area

10.77 m Güvenlik Alanı / Safety Area

PT
65



8.95 m
6.35 m

6.57 m Oturma Alanı / Sitting Area | _____
9.07 m Güvenlik Alanı / Safety Area | _____

PT
66

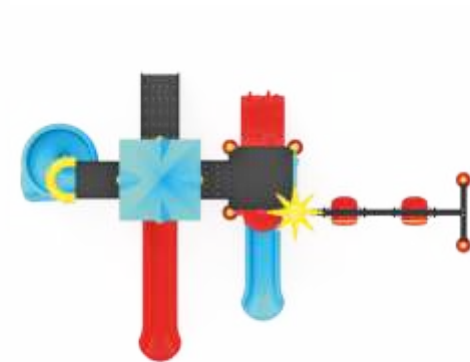

7.66 m
5.16 m

8.04 m Oturma Alanı / Sitting Area | _____
10.04 m Güvenlik Alanı / Safety Area | _____

PT
67

YAŞ GRUBU
Age

3+



Max
DÜŞME YÜKSEKLİĞİ
Fall Height

1.5m



6.07 m

9.07 m

7.16 m Oturma Alanı / Sitting Area

9.66 m Güvenlik Alanı / Safety Area

PT
68

YAŞ GRUBU
Age

3+



Max
DÜŞME YÜKSEKLİĞİ
Fall Height

1.5m

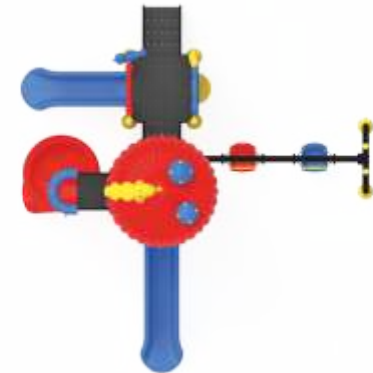

6.56 m

9.06 m

6.29 m Oturma Alanı / Sitting Area

8.79 m Güvenlik Alanı / Safety Area

PT
69



6.35 m
3.35 m

8.60 m Oturma Alanı / Sitting Area | _____
11.10 m Güvenlik Alanı / Safety Area | _____

PT
70



6.20 m
3.70 m

6.75 m Oturma Alanı / Sitting Area | _____
9.25 m Güvenlik Alanı / Safety Area | _____

PT
71

YAŞ GRUBU

Age

3+



Max

DÜŞME YÜKSEKLİĞİ

Fall Height

1m



5.73 m

8.73 m

6.50 m Oturma Alanı / Sitting Area

8.50 m Güvenlik Alanı / Safety Area

PT
72

YAŞ GRUBU

Age

3+



Max

DÜŞME YÜKSEKLİĞİ

Fall Height

1m



5.73 m

8.73 m

6.50 m Oturma Alanı / Sitting Area

8.50 m Güvenlik Alanı / Safety Area

PT
73

YAŞ GRUBU

Age

3+



Max

DÜŞME YÜKSEKLİĞİ

Fall Height

1m



8,73 m
5,73 m

6.50 m Oturma Alanı / Sitting Area | _____

8.50 m Güvenlik Alanı / Safety Area | _____

PT
74

YAŞ GRUBU

Age

3+



Max

DÜŞME YÜKSEKLİĞİ

Fall Height

1m



10,14 m
7,14 m

12.50 m Oturma Alanı / Sitting Area | _____

15.50 m Güvenlik Alanı / Safety Area | _____

PT
75

YAŞ GRUBU

Age

3+



Max
DÜŞME YÜKSEKLİĞİ

Fall Height

1.5m



8.87 m

5.87 m

5.66 m Oturma Alanı / Sitting Area | _____

7.66 m Güvenlik Alanı / Safety Area | _____

PT
76

YAŞ GRUBU

Age

3+



Max
DÜŞME YÜKSEKLİĞİ

Fall Height

1.5m



5.87 m

8.87 m

5.62 m Oturma Alanı / Sitting Area | _____

7.62 m Güvenlik Alanı / Safety Area | _____

PT
77

YAŞ GRUBU

Age

3+



Max
DÜŞME YÜKSEKLİĞİ

Fall Height

1.5m



10.13 m
7.13 m

5.58 m Oturma Alanı / Sitting Area | _____

7.58 m Güvenlik Alanı / Safety Area | _____

PT
78

YAŞ GRUBU

Age

5+



Max
DÜŞME YÜKSEKLİĞİ

Fall Height

2m



7.35 m
4.74 m

5.73 m Oturma Alanı / Sitting Area | _____

8.24 m Güvenlik Alanı / Safety Area | _____

PT
79

YAŞ GRUBU

Age

3+



Max

DÜŞME YÜKSEKLİĞİ

Fall Height

1.5m



5.00 m

8.00 m

6.82 m Oturma Alanı / Sitting Area

8.82 m Güvenlik Alanı / Safety Area

PT
80

YAŞ GRUBU

Age

3+



Max

DÜŞME YÜKSEKLİĞİ

Fall Height

1.5m

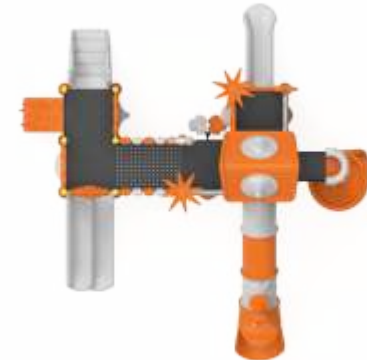

7.99 m

10.99 m

7.92 m Oturma Alanı / Sitting Area

10.42 m Güvenlik Alanı / Safety Area

PT
81

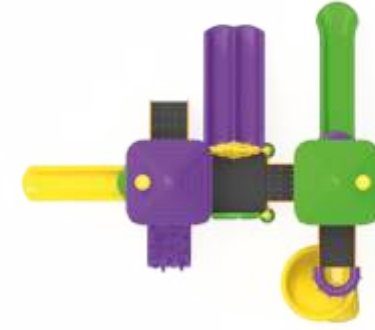

8.73 m
5.73 m

6.39 m Oturma Alanı / Sitting Area | _____
8.89 m Güvenlik Alanı / Safety Area | _____

PT
82



5.86 m
3.74 m

5.67 m Oturma Alanı / Sitting Area | _____
8.17 m Güvenlik Alanı / Safety Area | _____

PT
83

YAŞ GRUBU
Age

5+



Max
DÜŞME YÜKSEKLİĞİ
Fall Height

2m



5.99 m
8.99 m

5.88 m Oturma Alanı / Sitting Area

7.88 m Güvenlik Alanı / Safety Area

PT
84

YAŞ GRUBU
Age

3+



Max
DÜŞME YÜKSEKLİĞİ
Fall Height

1.5m

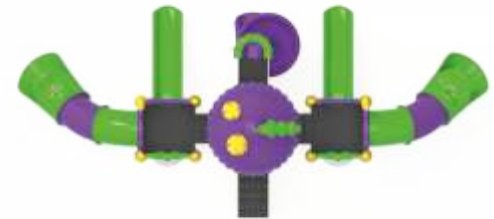

4.55 m
6.61 m

10.09 m Oturma Alanı / Sitting Area

12.21 m Güvenlik Alanı / Safety Area

PT
85

YAŞ GRUBU
Age

3+



Max
DÜŞME YÜKSEKLİĞİ
Fall Height

1.5m



6.54 m
4.54 m

5.73 m Oturma Alanı / Sitting Area | _____

8.73 m Güvenlik Alanı / Safety Area | _____

PT
86

YAŞ GRUBU
Age

3+



Max
DÜŞME YÜKSEKLİĞİ
Fall Height

1.5m

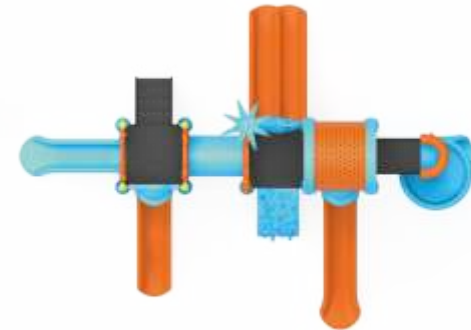

9.07 m
6.07 m

8.48 m Oturma Alanı / Sitting Area | _____

11.48 m Güvenlik Alanı / Safety Area | _____

PT
87

YAŞ GRUBU

Age

5+



Max
DÜŞME YÜKSEKLİĞİ

Fall Height

2m

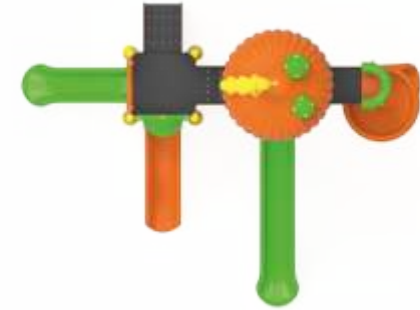

5.44 m

7.94 m

7.11 m Oturma Alanı / Sitting Area

10.11 m Güvenlik Alanı / Safety Area

PT
88

YAŞ GRUBU

Age

3+



Max
DÜŞME YÜKSEKLİĞİ

Fall Height

1m



3.60 m

6.10 m

7.71 m Oturma Alanı / Sitting Area

10.21 m Güvenlik Alanı / Safety Area

PT
89

YAŞ GRUBU

Age

5+



Max

DÜŞME YÜKSEKLİĞİ

Fall Height

2m



7.67 m
5.10 m

6.59 m Oturma Alanı / Sitting Area | _____

9.14 m Güvenlik Alanı / Safety Area | _____

PT
90

YAŞ GRUBU

Age

3+



Max

DÜŞME YÜKSEKLİĞİ

Fall Height

1m



7.90 m
5.40 m

5.20 m Oturma Alanı / Sitting Area | _____

7.20 m Güvenlik Alanı / Safety Area | _____

PT
91

YAŞ GRUBU
Age

3+



Max
DÜŞME YÜKSEKLİĞİ
Fall Height

1.5m



5.92 m

8.42 m

7.44 m Oturma Alanı / Sitting Area

9.94 m Güvenlik Alanı / Safety Area

PT
92

YAŞ GRUBU
Age

3+



Max
DÜŞME YÜKSEKLİĞİ
Fall Height

1.5m



3.49 m

5.99 m

7.65 m Oturma Alanı / Sitting Area

10.65 m Güvenlik Alanı / Safety Area

PT
93

YAŞ GRUBU

Age

3+



Max
DÜŞME YÜKSEKLİĞİ

Fall Height

1.5m

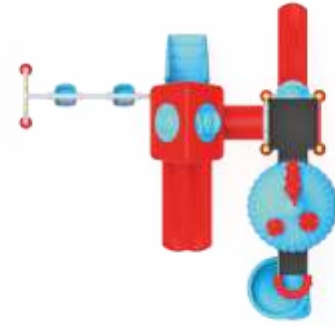

9.95 m
6.95 m

6.99 m Oturma Alanı / Sitting Area | _____

8.99 m Güvenlik Alanı / Safety Area | _____

PT
94

YAŞ GRUBU

Age

3+



Max
DÜŞME YÜKSEKLİĞİ

Fall Height

1.5m



9.95 m
6.95 m

6.68 m Oturma Alanı / Sitting Area | _____

8.88 m Güvenlik Alanı / Safety Area | _____

PT
95

YAŞ GRUBU
Age

3+



Max
DÜŞME YÜKSEKLİĞİ
Fall Height

1.5m



6.27 m

9.27 m

8.86 m Oturma Alanı / Sitting Area | _____
10.86 m Güvenlik Alanı / Safety Area | _____

PT
96

YAŞ GRUBU
Age

5+



Max
DÜŞME YÜKSEKLİĞİ
Fall Height

2m

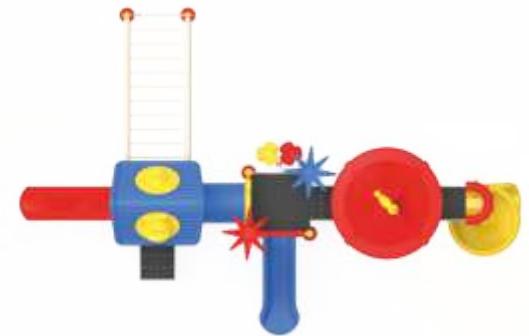

6.24 m

8.74 m

9.54 m Oturma Alanı / Sitting Area | _____
12.54 m Güvenlik Alanı / Safety Area | _____

PT
97

YAŞ GRUBU

Age

3+



Max
DÜŞME YÜKSEKLİĞİ

Fall Height

2m



8.73 m
8.00 m

9.54 m Oturma Alanı / Sitting Area

12.54 m Güvenlik Alanı / Safety Area

PT
98

YAŞ GRUBU

Age

3+



Max
DÜŞME YÜKSEKLİĞİ

Fall Height

1.5m

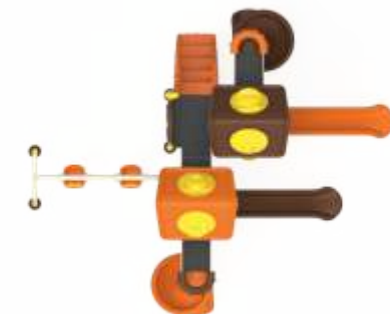

9.81 m
6.81 m

8.13 m Oturma Alanı / Sitting Area

11.13 m Güvenlik Alanı / Safety Area

PT
99

YAŞ GRUBU
Age

3+



Max
DÜŞME YÜKSEKLİĞİ
Fall Height

1.5m

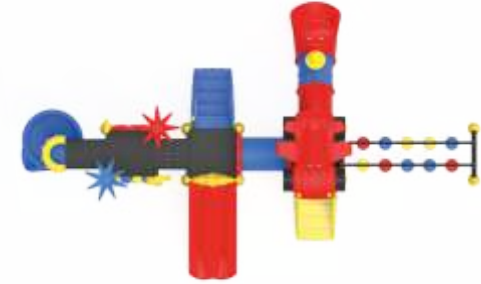

9.27 m

6.27 m

10.35 m Oturma Alanı / Sitting Area

12.85 m Güvenlik Alanı / Safety Area

PT
100

YAŞ GRUBU
Age

3+



Max
DÜŞME YÜKSEKLİĞİ
Fall Height

1.5m



6.94 m

9.44 m

8.49 m Oturma Alanı / Sitting Area

10.99 m Güvenlik Alanı / Safety Area

PT
101

YAŞ GRUBU

Age

3+



Max
DÜŞME YÜKSEKLİĞİ

Fall Height

1.5m



7.89 m
5.39 m

11.10 m Oturma Alanı / Sitting Area

13.10 m Güvenlik Alanı / Safety Area

PT
102

YAŞ GRUBU

Age

5+



Max
DÜŞME YÜKSEKLİĞİ

Fall Height

2m

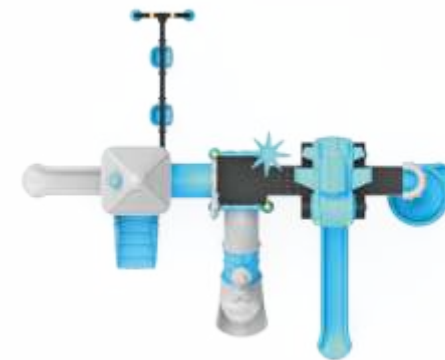

10.23 m
7.73 m

9.43 m Oturma Alanı / Sitting Area

12.43 m Güvenlik Alanı / Safety Area

PT
103

YAŞ GRUBU
Age

3+



Max
DÜŞME YÜKSEKLİĞİ
Fall Height

1.5m



6.97 m

9.47 m

11.28 m Oturma Alanı / Sitting Area | _____

14.28 m Güvenlik Alanı / Safety Area | _____

PT
104

YAŞ GRUBU
Age

3+



Max
DÜŞME YÜKSEKLİĞİ
Fall Height

1.5m



8.65 m

11.15 m

14.25 m Oturma Alanı / Sitting Area | _____

17.25 m Güvenlik Alanı / Safety Area | _____

**PT
105**

YAŞ GRUBU
Age
3+

Max
DÜŞME YÜKSEKLİĞİ
Fall Height
1.5m



12.52 m
9.52 m

15.60 m Oturma Alanı / Sitting Area | _____
18.60 m Güvenlik Alanı / Safety Area | _____

**PT
106**

YAŞ GRUBU
Age
3+

Max
DÜŞME YÜKSEKLİĞİ
Fall Height
1.5m



8.59 m
6.09 m

6.82 m Oturma Alanı / Sitting Area | _____
9.82 m Güvenlik Alanı / Safety Area | _____

PT
107

YAŞ GRUBU

Age

3+



Max

DÜŞME YÜKSEKLİĞİ

Fall Height

1m



4.23 m

6.47 m



9.64 m Oturma Alanı / Sitting Area | _____

11.64 m Güvenlik Alanı / Safety Area | _____

PT
108

YAŞ GRUBU

Age

3+



Max

DÜŞME YÜKSEKLİĞİ

Fall Height

1.5m



5.60 m

8.11 m



9.21 m Oturma Alanı / Sitting Area | _____

12.21 m Güvenlik Alanı / Safety Area | _____

Playground Sets

**PT
109**

YAŞ GRUBU

Age

3+



Max
DÜŞME YÜKSEKLİĞİ

Fall Height

1.5m

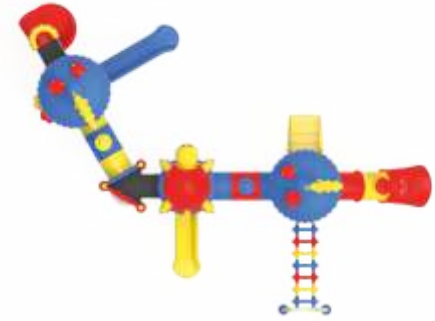

10.59 m
8.47 m

11.23 m Oturma Alanı / Sitting Area

13.73 m Güvenlik Alanı / Safety Area

**PT
110**

YAŞ GRUBU

Age

3+



Max
DÜŞME YÜKSEKLİĞİ

Fall Height

1.5m



10.64 m
8.64 m

11.23 m Oturma Alanı / Sitting Area

13.35 m Güvenlik Alanı / Safety Area

PT
111

YAŞ GRUBU
Age

3+



Max
DÜŞME YÜKSEKLİĞİ
Fall Height

1.5m

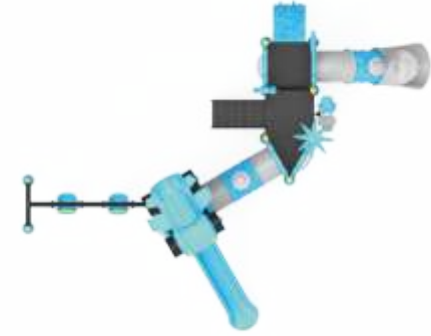

5.73 m

8.73 m

6.50 m Oturma Alanı / Sitting Area

8.50 m Güvenlik Alanı / Safety Area

PT
112

YAŞ GRUBU
Age

5+



Max
DÜŞME YÜKSEKLİĞİ
Fall Height

2m

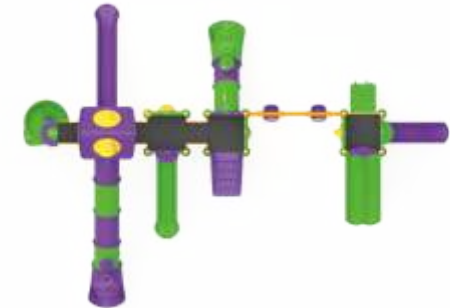

9.12 m

12.12 m

13.00 m Oturma Alanı / Sitting Area

16.00 m Güvenlik Alanı / Safety Area

PT
113

YAŞ GRUBU

Age

3+



Max
DÜŞME YÜKSEKLİĞİ

Fall Height

1.5m



9.05 m
6.05 m

10.49 m Oturma Alanı / Sitting Area | _____

12.49 m Güvenlik Alanı / Safety Area | _____

PT
114

YAŞ GRUBU

Age

3+



Max
DÜŞME YÜKSEKLİĞİ

Fall Height

1.5m



8.73 m
5.73 m

6.50 m Oturma Alanı / Sitting Area | _____

8.50 m Güvenlik Alanı / Safety Area | _____

PT
115

YAŞ GRUBU
Age

3+



Max
DÜŞME YÜKSEKLİĞİ
Fall Height

1m



5.73 m

8.73 m

6.50 m Oturma Alanı / Sitting Area

8.50 m Güvenlik Alanı / Safety Area

PT
116

YAŞ GRUBU
Age

3+



Max
DÜŞME YÜKSEKLİĞİ
Fall Height

1m



5.73 m

8.73 m

6.50 m Oturma Alanı / Sitting Area

8.50 m Güvenlik Alanı / Safety Area

PT
117

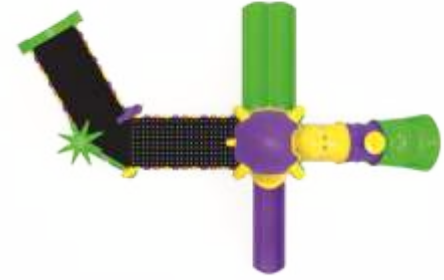

8.73 m
5.73 m

6.50 m Oturma Alanı / Sitting Area | _____
8.50 m Güvenlik Alanı / Safety Area | _____

PT
118



10.51 m
8.01 m

8.76 m Oturma Alanı / Sitting Area | _____
10.76 m Güvenlik Alanı / Safety Area | _____

PT
119

YAŞ GRUBU
Age

3+



Max
DÜŞME YÜKSEKLİĞİ
Fall Height

1.5m



5.73 m

8.73 m

6.50m Oturma Alanı / Sitting Area

8.50 m Güvenlik Alanı / Safety Area

PT
120

YAŞ GRUBU
Age

3+



Max
DÜŞME YÜKSEKLİĞİ
Fall Height

1m

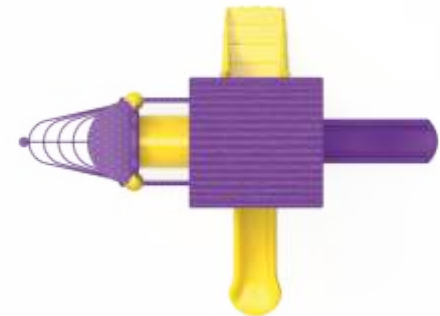

5.73 m

8.73 m

6.50m Oturma Alanı / Sitting Area

8.50 m Güvenlik Alanı / Safety Area

PT
121



8.73 m
5.73 m

6.50 m Oturma Alanı / Sitting Area | _____
8.50 m Güvenlik Alanı / Safety Area | _____

PT
122

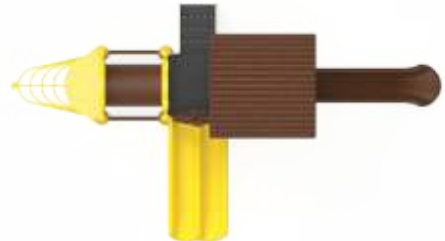

8.73 m
5.73 m

6.50 m Oturma Alanı / Sitting Area | _____
8.50 m Güvenlik Alanı / Safety Area | _____

PT
123

YAŞ GRUBU
Age

3+



Max
DÜŞME YÜKSEKLİĞİ
Fall Height

1.5m



5.73 m

8.73 m

6.50 m Oturma Alanı / Sitting Area | _____

8.50 m Güvenlik Alanı / Safety Area | _____

PT
124

YAŞ GRUBU
Age

3+



Max
DÜŞME YÜKSEKLİĞİ
Fall Height

2m

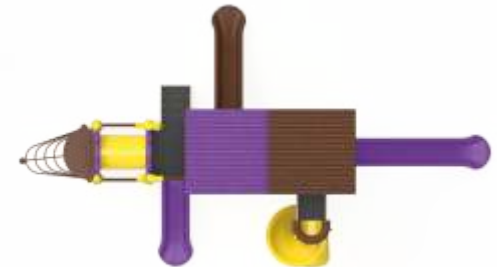

5.73 m

8.73 m

6.50 m Oturma Alanı / Sitting Area | _____

8.50 m Güvenlik Alanı / Safety Area | _____

PT
125



12.76 m
8.76 m

9.03 m Oturma Alanı / Sitting Area
12.03 m Güvenlik Alanı / Safety Area

PT
126



5.73 m
8.73 m

6.50 m Oturma Alanı / Sitting Area
8.50 m Güvenlik Alanı / Safety Area

PT
127

YAŞ GRUBU

Age

5+



Max
DÜŞME YÜKSEKLİĞİ

Fall Height

2m

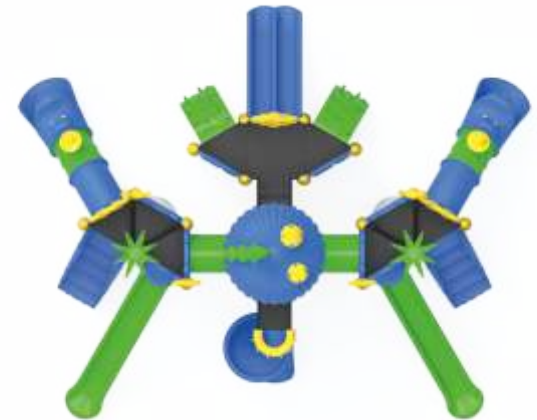

11.15 m
8.15 m

10.08 m Oturma Alanı / Sitting Area

13.08 m Güvenlik Alanı / Safety Area

PT
128

YAŞ GRUBU

Age

5+



Max
DÜŞME YÜKSEKLİĞİ

Fall Height

2m



5.73 m

8.73 m

6.50 m Oturma Alanı / Sitting Area

8.50 m Güvenlik Alanı / Safety Area

PT
129

YAŞ GRUBU

Age

5+



Max
DÜŞME YÜKSEKLİĞİ

Fall Height

2.8m



12.17 m
9.17 m

10.83 m Oturma Alanı / Sitting Area

13.83 m Güvenlik Alanı / Safety Area

PT
130

YAŞ GRUBU

Age

5+



Max
DÜŞME YÜKSEKLİĞİ

Fall Height

2.8m

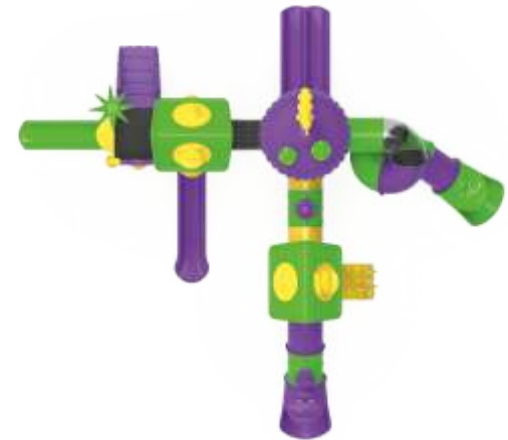

9.48 m

12.48 m

10.63 m Oturma Alanı / Sitting Area

13.63 m Güvenlik Alanı / Safety Area

PT
131



8.72 m
6.22 m

13.58 m Oturma Alanı / Sitting Area | _____
16.58 m Güvenlik Alanı / Safety Area | _____

PT
132

YAŞ GRUBU

Age

5+



Max

DÜŞME YÜKSEKLİĞİ

Fall Height

2.8m



4.75 m

7.25 m

13.58 m Oturma Alanı / Sitting Area

16.58 m Güvenlik Alanı / Safety Area

PT
133

YAŞ GRUBU

Age

5+



Max
DÜŞME YÜKSEKLİĞİ

Fall Height

2.8m

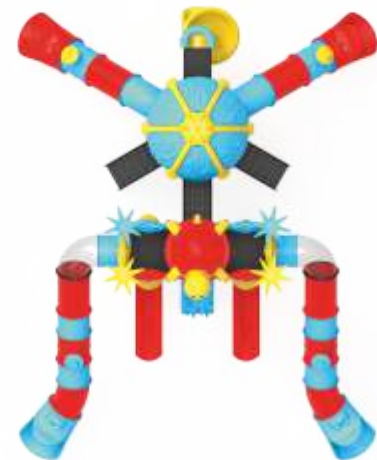

13.31 m
10.69 m

8.51 m Oturma Alanı / Sitting Area

10.51 m Güvenlik Alanı / Safety Area

PT
134

YAŞ GRUBU

Age

5+



Max
DÜŞME YÜKSEKLİĞİ

Fall Height

2.8m



8.34 m

11.34 m

10.94 m Oturma Alanı / Sitting Area

10.51 m Güvenlik Alanı / Safety Area

PT
135

YAŞ GRUBU

Age

5+



Max
DÜŞME YÜKSEKLİĞİ

Fall Height

2.8m



14,16 m
11,16 m

9.20 m Oturma Alanı / Sitting Area
13.20 m Güvenlik Alanı / Safety Area

PT
136

YAŞ GRUBU

Age

5+



Max
DÜŞME YÜKSEKLİĞİ

Fall Height

3m



9.94 m

13.94 m

12.47 m Oturma Alanı / Sitting Area

16.47 m Güvenlik Alanı / Safety Area

PT
137

YAŞ GRUBU

Age

5+



Max

DÜŞME YÜKSEKLİĞİ

Fall Height

2m

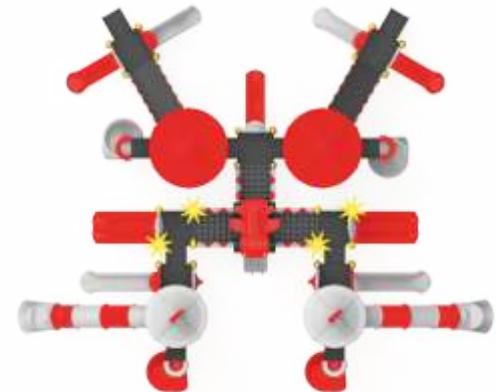

6.88 m
3.38 m

3.46 m Oturma Alanı / Sitting Area

6.46 m Güvenlik Alanı / Safety Area

PT
138

YAŞ GRUBU

Age

5+



Max
DÜŞME YÜKSEKLİĞİ

Fall Height

2.8m

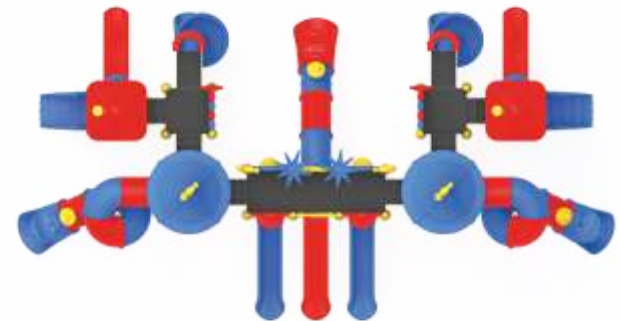

7.91 m

11.94 m

10.03 m Oturma Alanı / Sitting Area

18.53 m Güvenlik Alanı / Safety Area

PT
139

YAŞ GRUBU

Age

5+



Max
DÜŞME YÜKSEKLİĞİ

Fall Height

2.8m



16.42 m
12.42 m

14.79 m Oturma Alanı / Sitting Area

17.79 m Güvenlik Alanı / Safety Area

PT
140

YAŞ GRUBU

Age

5+



Max
DÜŞME YÜKSEKLİĞİ

Fall Height

2.8m

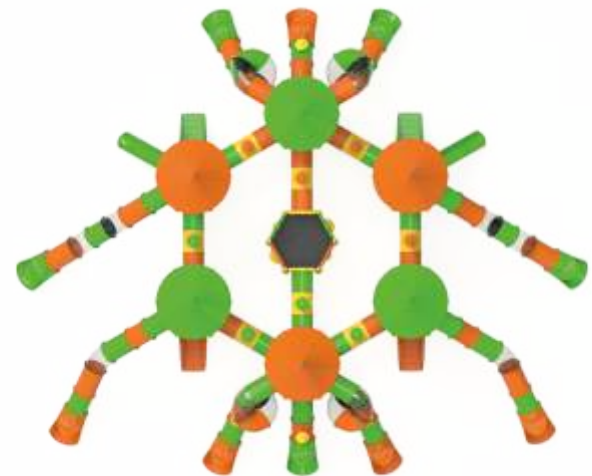

16.66 m
20.66 m

20.05 m Oturma Alanı / Sitting Area
23.55 m Güvenlik Alanı / Safety Area

Playground Sets

PT
141

YAŞ GRUBU
Age
3+

Max. DÜŞME YÜKSEKLİĞİ
Fall Height
1m



PT
142

YAŞ GRUBU
Age
3+

Max. DÜŞME YÜKSEKLİĞİ
Fall Height
1.5m

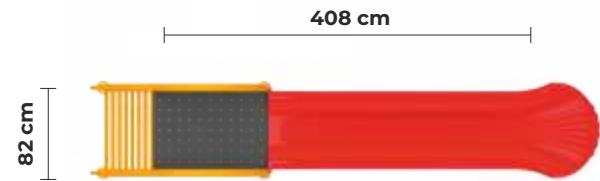

PT
143

YAŞ GRUBU
Age
3+

Max. DÜŞME YÜKSEKLİĞİ
Fall Height
2m

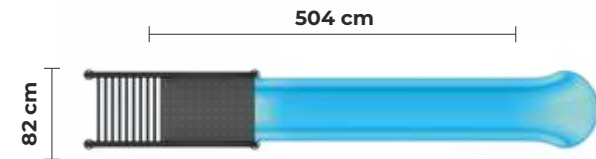

PT
144

YAŞ GRUBU
Age
3+

Max. DÜŞME YÜKSEKLİĞİ
Fall Height
1.5m

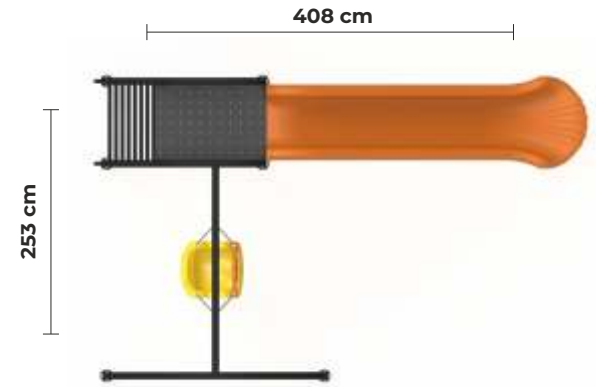

PT
145

YAŞ GRUBU
Age
3+

Max. DÜŞME YÜKSEKLİĞİ
Fall Height
2m

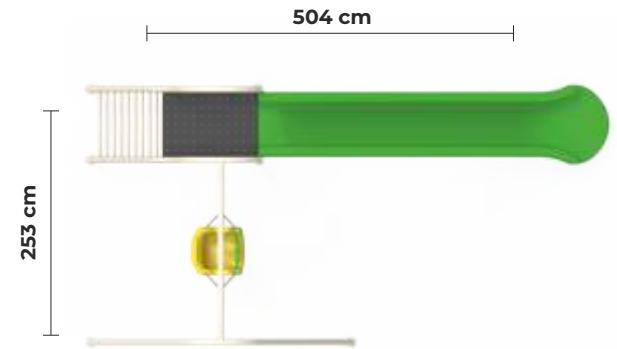

PT
146

YAŞ GRUBU
Age
3+

Max. DÜŞME YÜKSEKLİĞİ
Fall Height
1m



PT
147

YAŞ GRUBU
Age
3+

Max. DÜŞME YÜKSEKLİĞİ
Fall Height
1.5m

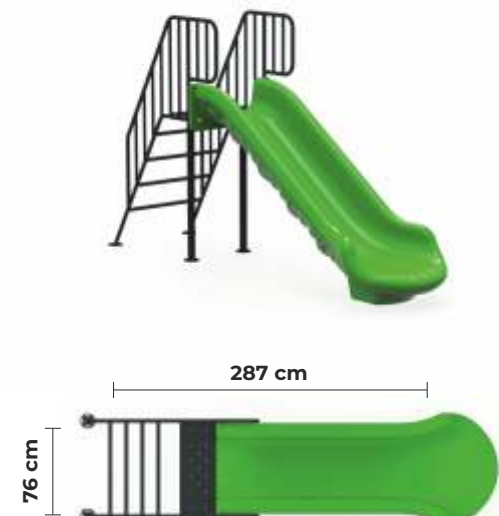



Aksesuarlar

Playground Accessories

PC
01

AT FİĞÜRLÜ DÖNME DOLAP
HORSE FIGURED MERRY GO ROUND



∅
296 cm



PC
02

AT FİĞÜRLÜ EKO DÖNME DOLAP
HORSE FIGURED ECO MERRY GO ROUND



∅
262 cm



PC
03

PLASTİK DÖNME DOLAP
PLASTIC MERRY GO ROUND



∅
150 cm



PC
04

MOTOR FİĞÜRLÜ DÖNME DOLAP
MOTORCYCLE FIGURED MERRY GO ROUND



∅
170 cm



Playground Accessories

PC
05

KEDİ FİĞÜRLÜ DÖNME DOLAP
CAT FIGURED MERRY GO ROUND



∅
170 cm

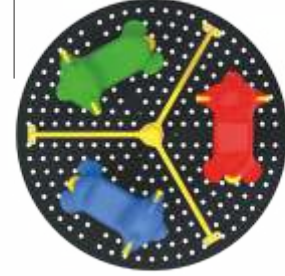

PC
06

KOLTUKLU DÖNME DOLAP
MERRY GO ROUND WITH SEATS



∅
155 cm



PC
07

ENGELSİZ DÖNME DOLAP
MERRY GO ROUND FOR DISABLED



∅
205 cm



PC
08

DÖRT KOLLU DÖNME DOLAP
FOUR ARMED MERRY GO ROUND



189 cm

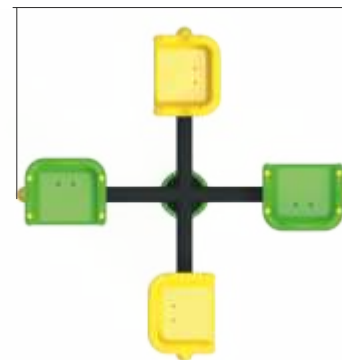

PC
09

MİNİ DÖNME DOLAP
MINI MERRY GO ROUND



113 cm



PC
10

İDEAL DÖNME DOLAP
IDEAL MERRY GO ROUND



∅
155 cm

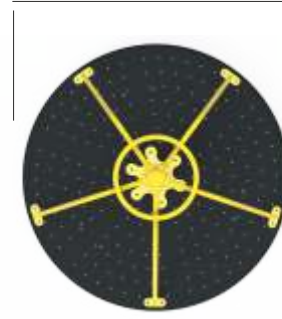

PC
11

EKO DÖNME DOLAP
ECO MERRY GO ROUND



∅
120 cm



PC
12

KLASİK DÖNME DOLAP
CLASSICAL MERRY GO ROUND



∅
155 cm

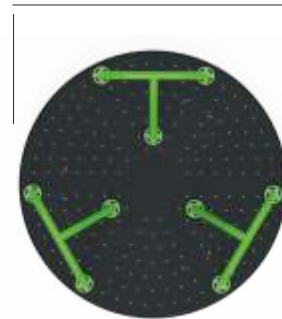

PC
13

KLASİK SALINCAK
CLASSICAL SWING

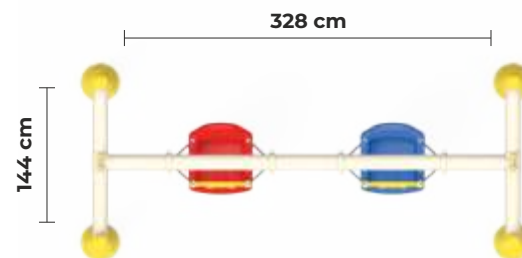

PC
14

EĞİMLİ KLASİK SALINCAK
CURVED CLASSICAL SWING

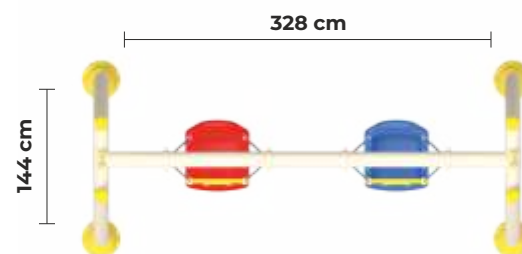

PC
15

EKO SALINCAK
ECO CLASSICAL SWING

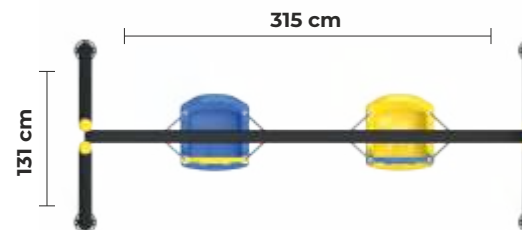

PC
16

HDPE PANOLU SALINCAK
HDP PANEL SWING

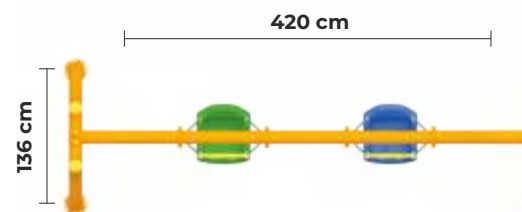

PC
17

EĐİMLİ ENGELSİZ SALINCAK
CURVED SWING FOR DISABLED

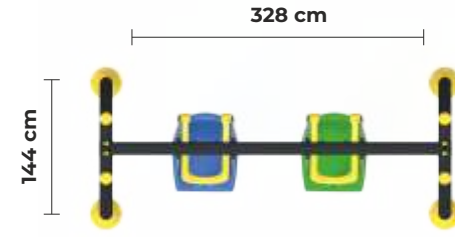

PC
18

EĐİMLİ EBEVEYN SALINCAK
CURVED SWING FOR PARENT AND CHILD

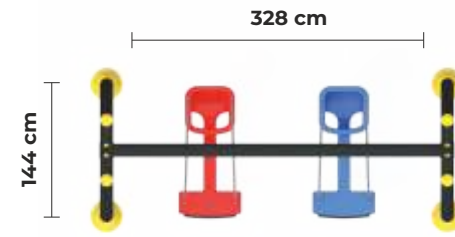

PC
19

KLASİK ANNE & ÇOCUK SALINCAK
CLASSICAL SWING FOR PARENT AND CHILD

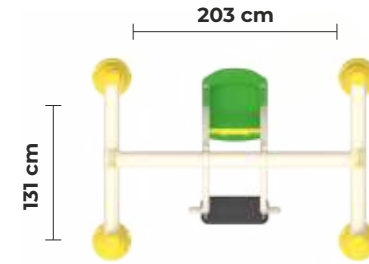

PC
20

EĐİMLİ ANNE & BEBEK SALINCAK
CURVED SWING FOR PARENT AND BABY

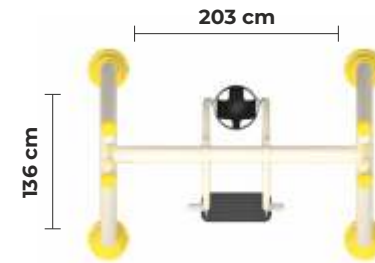

Playground Accessories

PC
21

ENGELSİZ SALINCAK
SWING FOR DISABLED

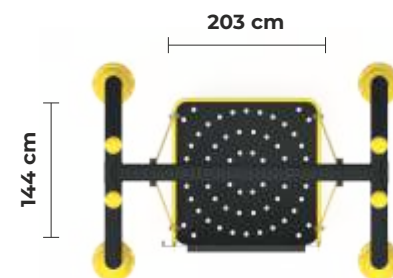

PC
22

KULUÇKA SALINCAK
BIRD NEST SWING

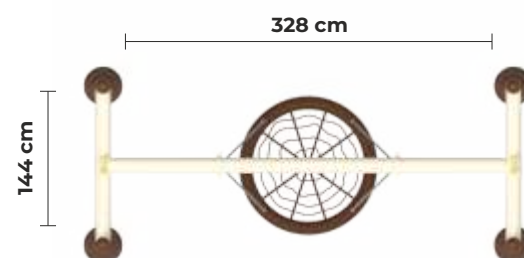

PC
23

EKO KULUÇKA SALINCAK
ECO BIRD NEST SWING

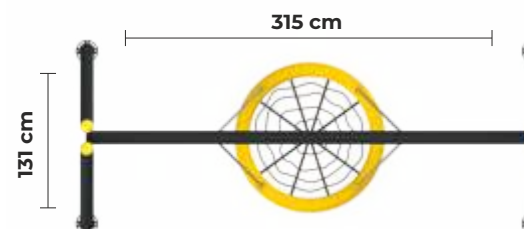

PC
24

EĞİMLİ KULUÇKA SALINCAK
CURVED BIRD NEST SWING

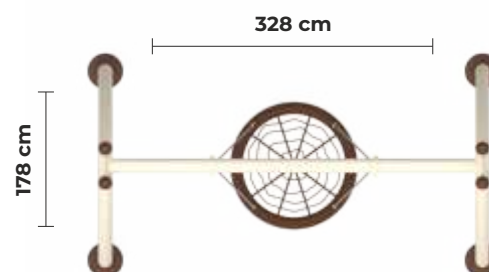

PC
25

KARTAL SALINCAK VE TAHTEREVALİ
EAGLE SWING AND SEESAW

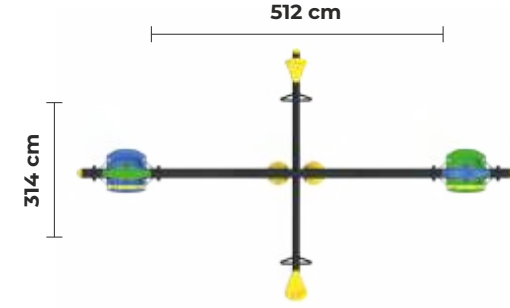

PC
26

KARTAL SALINCAK
EAGLE SWING



PC
27

KARTAL SALINCAK VE FİGÜRLÜ TAHTEREVALİ
EAGLE SWING AND FIGURED SEESAW

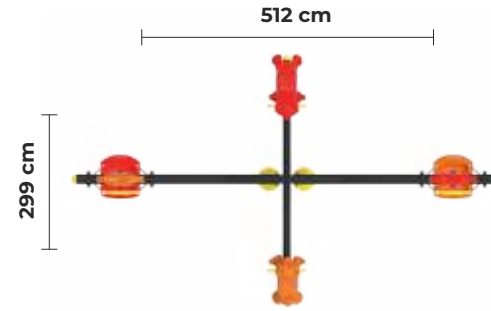

PC
28

EĞİMLİ GONDOL SALINCAK
CURVED SWING BOAT

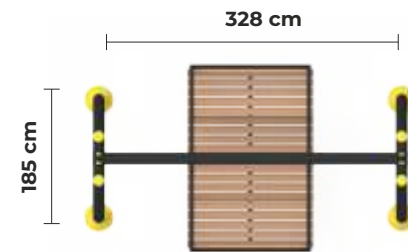

PC
29

DÖRTLÜ KLASİK SALINCAK
QUADRUPLE CLASSICAL SWING

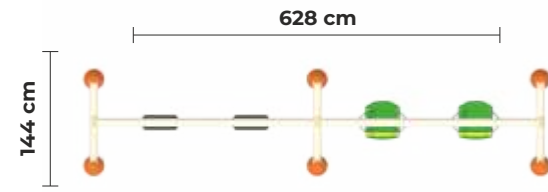

PC
30

DÖRTLÜ SALINCAK
QUADRUPLE SWING

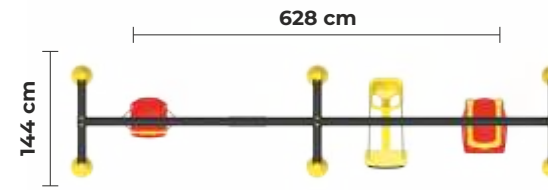

PC
31

BEŞGEN KLASİK SALINCAK
PENTAGONAL CLASSICAL SWING

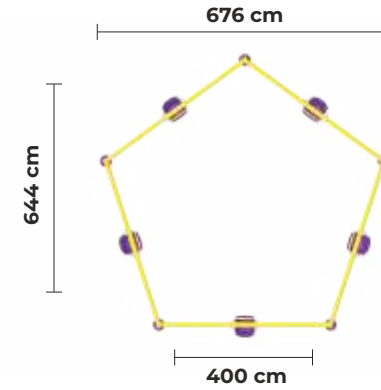

PC
32

BEŞGEN SALINCAK
PENTAGONAL SWING

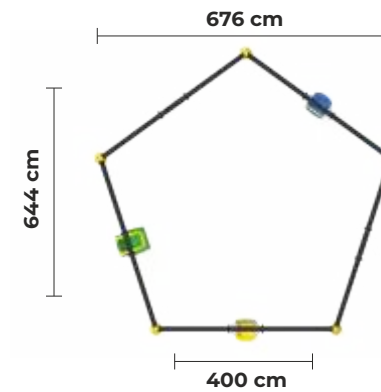

PC
33

TEKLİ KLASİK TAHTEREVALLI
SINGLE CLASSICAL SEESAW

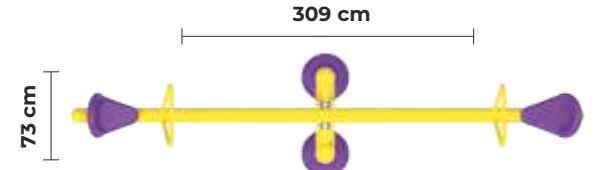

PC
34

TEKLİ TAHTERERALLI
SINGLE SEESAW



PC
35

YILDIZ TAHTEREVALLI
STAR SEESAW

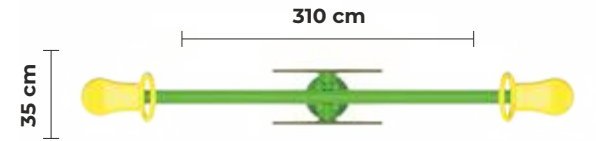

PC
36

İKİLİ HDPE OTURAKLI TAHTEREVALLI
SEESAW WITH DOUBLE HDPE SEATS

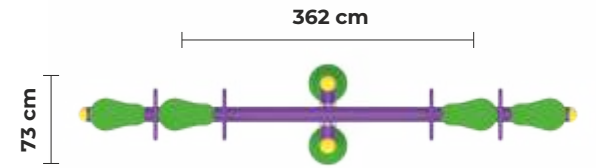

PC
37

KEDİ FİGÜRLÜ TEK Lİ TAHTEREVALLİ
CAT FIGURED SINGLE SEESAW

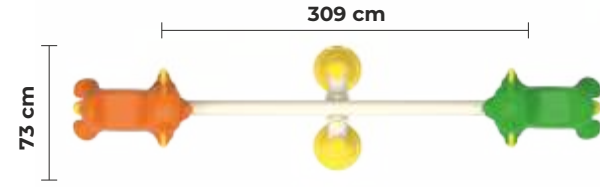

PC
38

TAVŞAN VE KEDİ FİGÜRLÜ TEK Lİ TAHTEREVALLİ
RABBIT AND CAT FIGURED SINGLE SEESAW

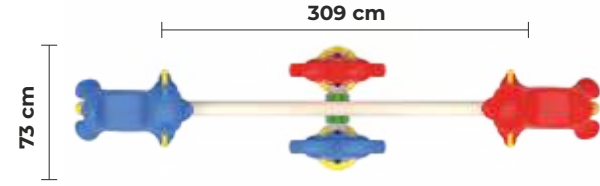

PC
39

İKİLİ KLASİK TAHTEREVALLİ
CLASSICAL SEESAW WITH DOUBLE SEATS

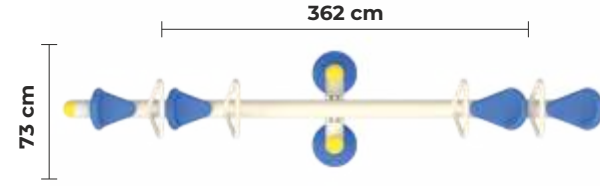

PC
40

TAVŞAN FİGÜRLÜ İKİLİ TAHTEREVALLİ
RABBIT FIGURED SEESAW WITH DOUBLE SEAT

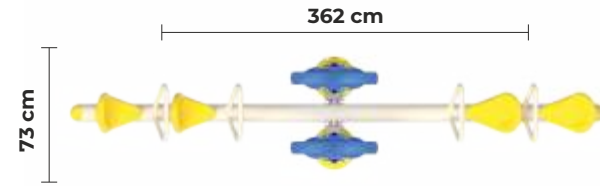

PC
41

ÇİFTLİ KLASİK TAHTEREVALLI
DOUBLE CLASSICAL SEESAW

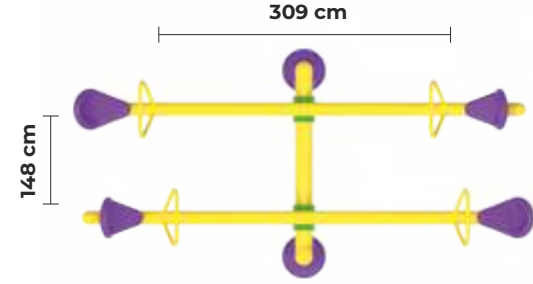

PC
42

TAVŞAN FİGÜRLÜ ÇİFTLİ TAHTEREVALLI
RABBIT FIGURET DOUBLE SEESAW



PC
43

TAVŞAN VE KEDİ FİGÜRLÜ ÇİFTLİ TAHTEREVALLI
RABBIT AND CAT FIGURED DOUBLE SEESAW

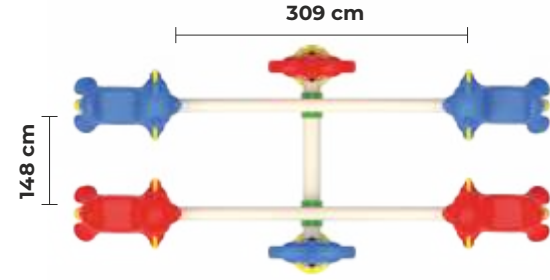

PC
44

ENGELSİZ TAHTEREVALLI
SEESAW FOR DISABLED

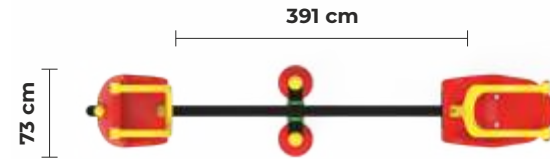

Playground Accessories

PC
45

HDPE ZIPZIP TAHTEREVALLI
HDPE SEESAW WITH SPRINGS



PC
46

HDPE AT FIGÜRLÜ TAHTEREVALLI
HDPE HORSE FIGURED SEESAW



PC
47

ÇİT KÖPRÜ
FENCE BRIDGE

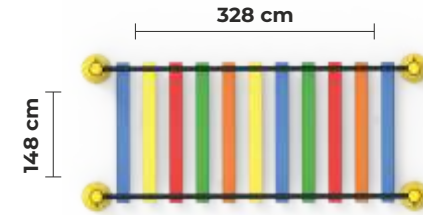

PC
48

İDEAL TIRMANMA
IDEAL CLIMBING

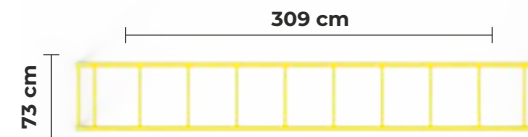

Aksesuarlar

PC
49

BARFİKS TIRMANMA
PULL UP CLIMBING

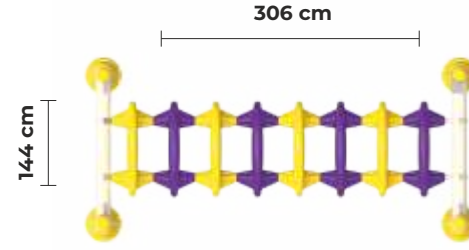

PC
50

KÖPRÜ TIRMANMA
BRIDGE CLIMBING

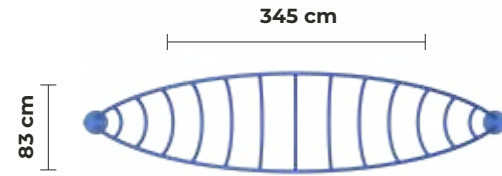

PC
51

TARZAN TIRMANMA
TARZAN CLIMBING

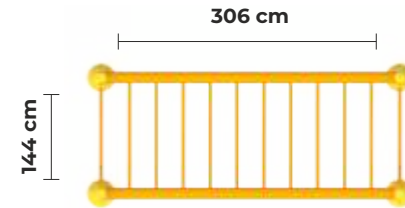

Playground Accessories

PC
52

DAİRESEL TRAMBOLİN
CIRCULAR TRAMPOLINE

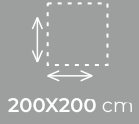
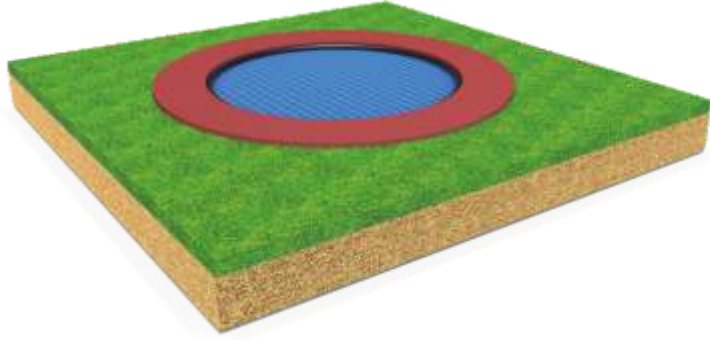

200X200 cm

PC
53

DESENLİ DAİRESEL TRAMBOLİN
PATTERNED CIRCULAR TRAMPOLINE

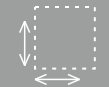
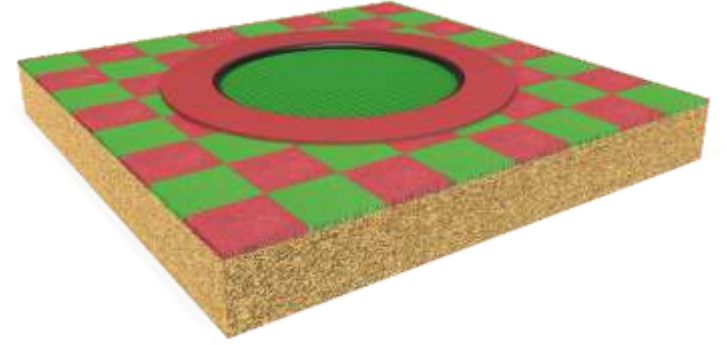

180X180 cm

PC
54

KARE TRAMBOLİN
SQUARE TRAMPOLINE

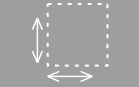

200X200 cm

PC
55

DESENLİ KARE TRAMBOLİN
PATTERNED SQUARE TRAMPOLINE



180X180 cm



PC
56

YAYLI ATV ZIPZIP
ATV SPRINGER WITH SPRING

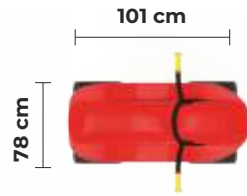

PC
60

YAYLI KURBAĞA ZIPZIP
FROG SPRINGER WITH SPRING

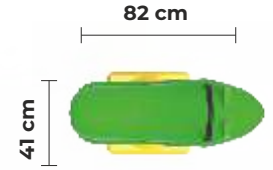

PC
57

YAYLI MOTOR ZIPZIP
MOTORCYCLE SPRINGER WITH SPRING

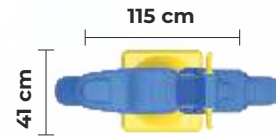

PC
61

YAYLI AT ZIPZIP
HORSE SPRINGER WITH SPRING

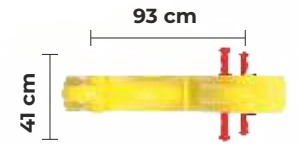

PC
58

YAYLI KEDİ ZIPZIP
CAT SPRINGER WITH SPRING

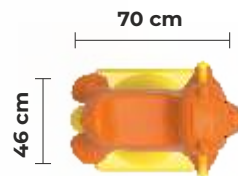

PC
62

YAYLI HDPE ASLAN ZIPZIP
HDPE LION SPRINGER WITH SPRING

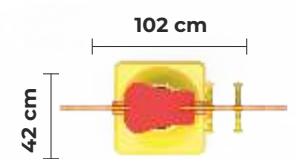

PC
59

YAYLI HDPE AT ZIPZIP
HDPE HORSE SPRINGER WITH SPRING

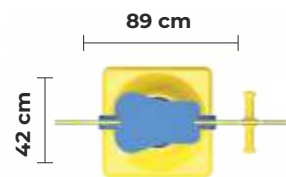

PC
63

YAYLI HDPE MOTOR ZIPZIP
HDPE MOTORCYCLE SPRINGER WITH SPRING

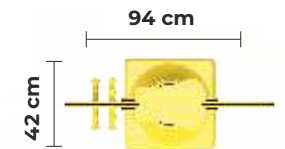

Playground Accessories

PC
64

HDPE DENGE ZIPZIP
HDPE BALANCE SPRINGER



92 cm

PC
68

YAYLI HDPE KAPLUMBAĞA ZIPZIP
HDPE TURTLE SPRINGER WITH SPRING

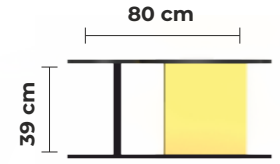

80 cm

39 cm

PC
65

YAYLI HDPE KÖPEK ZIPZIP
HDPE DOG SPRINGER WITH SPRING

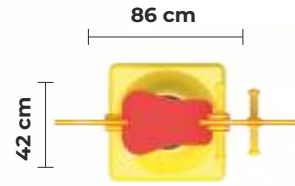

86 cm

42 cm

PC
69

YAYLI HDPE TAVŞAN ZIPZIP
HDPE RABBIT SPRINGER WITH SPRING

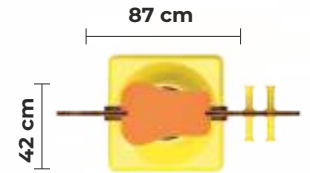

87 cm

42 cm

PC
66

YAYLI HDPE ARABA ZIPZIP
HDPE CAR SPRINGER WITH SPRING

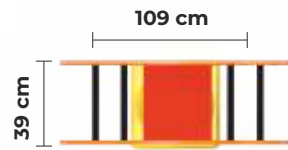

109 cm

39 cm

PC
70

YAYLI HDPE HORUZ ZIPZIP
HDPE ROOSTER SPRINGER WITH SPRING

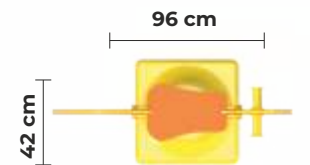

96 cm

42 cm

PC
67

YAYLI HDPE KELEBEK ZIPZIP
HDPE BUTTERFLY SPRINGER WITH SPRING

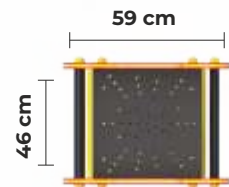

59 cm

46 cm

PC
71

YAYLI HDPE FİL ZIPZIP
HDPE ELEPHANT SPRINGER WITH SPRING

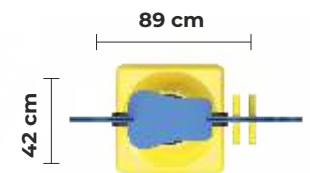

89 cm

42 cm

PC
72

YAYLI HDPE İTFAİYE ZIPZIP
HDPE FIRE TRUCK SPRINGER WITH SPRING

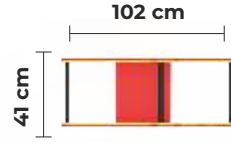

PC
73

YAYLI HDPE POLİS ARABASI ZIPZIP
HDPE POLICE CAR SPRINGER WITH SPRING

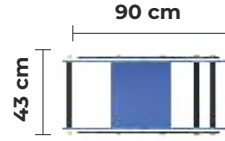

PC
74

MİNİ ZIPZIP
MINI SPRINGER

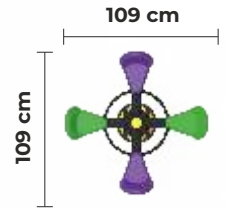

PC
75

TAHTEREVALLI ZIPZIP
SEESAW SPRINGER

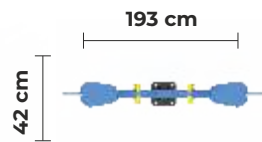

PC
76

ÇİT SAHNE
FENCE STAGE

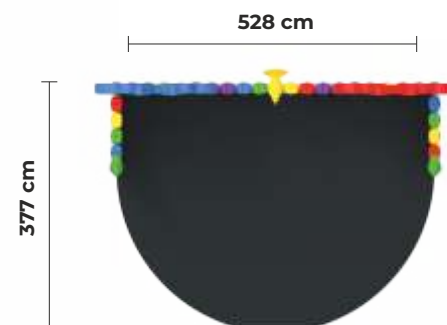

PC
77

HDPE SAHNE
HDPE STAGE

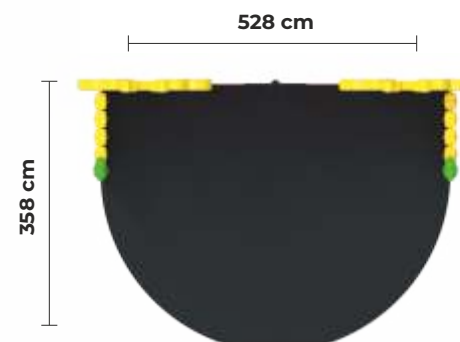



Diş Mekan Spor Aletleri

Outdoor Fitness Equipments

PF
01

BACAK AÇMA ALETİ
LEG STRETCHING EQUIPMENT

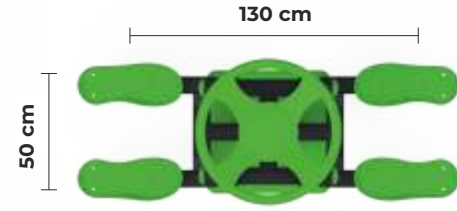

PF
02

BACAK İTME ALETİ
PUSH-OFF LEGS EQUIPMENT

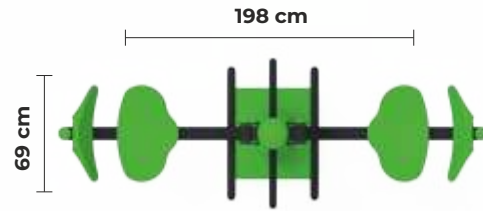

PF
03

ÇİFTLİ GEZİNİM ALETİ
DOUBLE WALKER

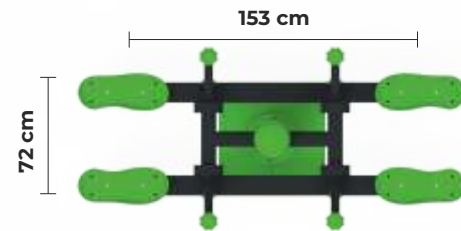

PF
04

ELİPTİK YÜRÜME ALETİ
ELLIPTICAL WALKER

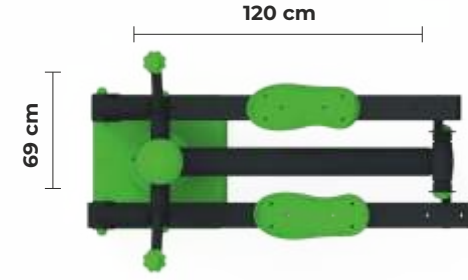

PF
05

İKİLİ SALINIM ALETİ
DOUBLE WAIST STRECHING EQUIPMENT

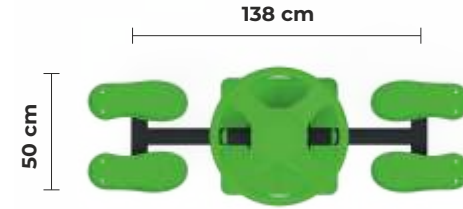
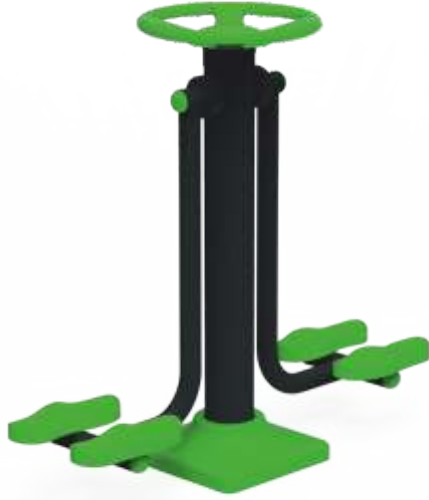

PF
06

KOL VE BİLEK ÇALIŞTIRMA ALETİ
WRIST AND ARM EXERCISE EQUIPMENT

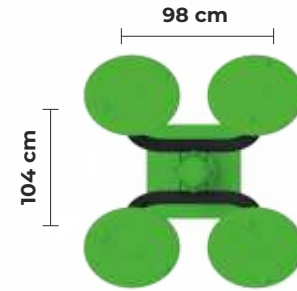

PF
07

KÜREK ÇEKME ALETİ
ROWING EQUIPMENT

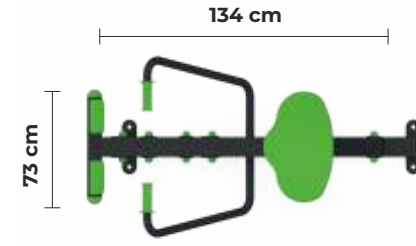

PF
08

MEKİK ÇEKME ALETİ
SIT UPS EQUIPMENT

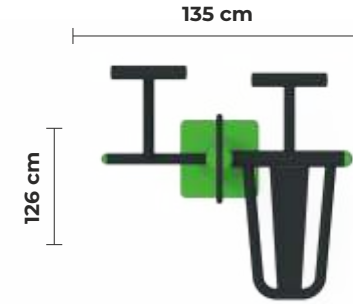

PF
09

OTURARAK VE AYAKTA BEL ESNETME ALETİ
WAIST STRETCHING EQUIPMENT BY SITTING AND STANDING

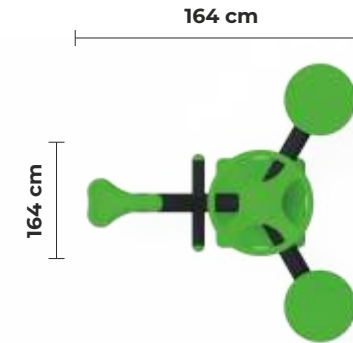

PF
10

STEP VE BİSİKLET
STEP - BICYCLE EQUIPMENT



PF
11

TEKLİ YÜRÜYÜŞ ALETİ
SINGLE WALKER

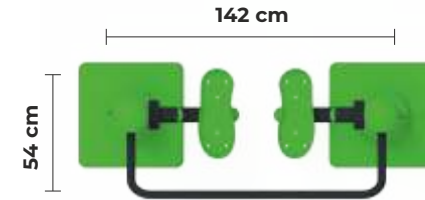

PF
12

VÜCUT GELİŞTİRME ALETİ
BODY - BUILDING EQUIPMENT

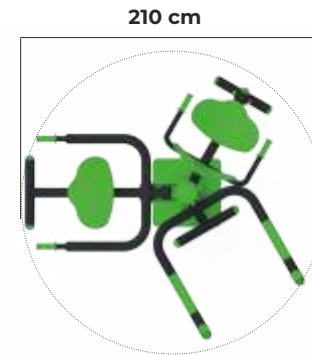



Kent Mobilyaları

Urban Furnitures

PM
01

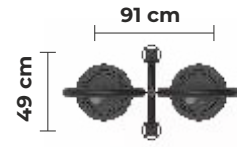

PM
05

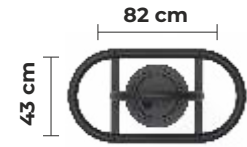

PM
02

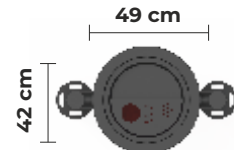

PM
06

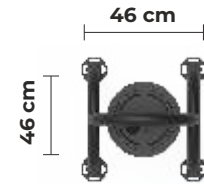

PM
03

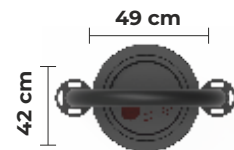

PM
07

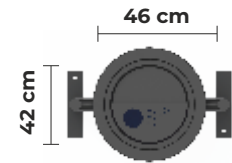

PM
04

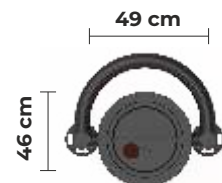

PM
08



PM
09

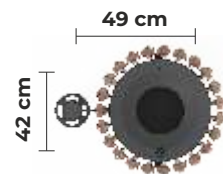

PM
12



PM
10

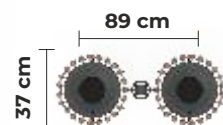

PM
13



PM
11

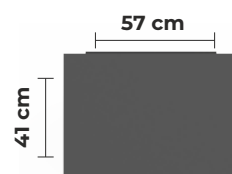

PM
14



PM
15

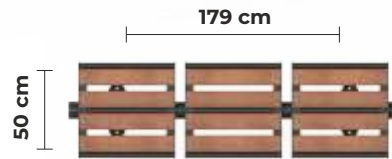

PM
18

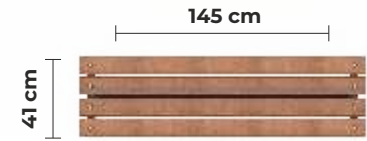

PM
16

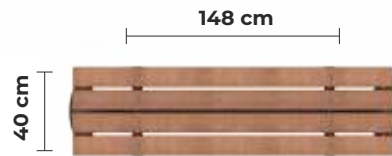

PM
19

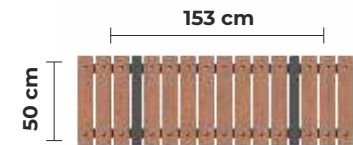

PM
17

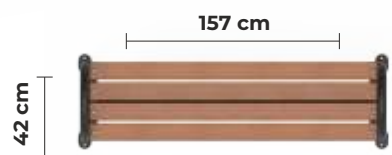

PM
20



PM
21

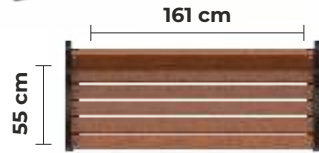

PM
24

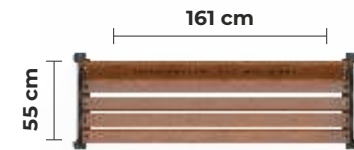

PM
22



PM
25

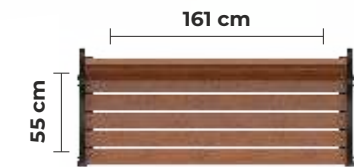

PM
23

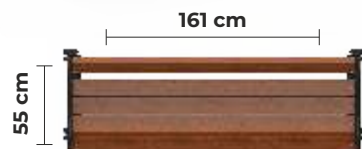

PM
26



PM
27



PM
30



PM
28

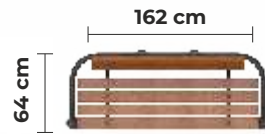

PM
31

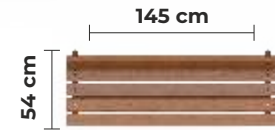

PM
29

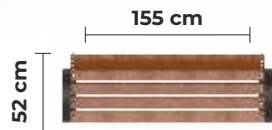

PM
32

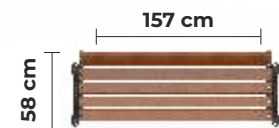

PM
33

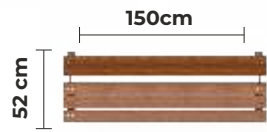

PM
35

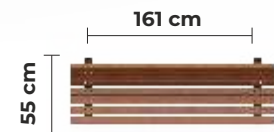

PM
34



PM
36

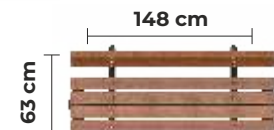

PM
37

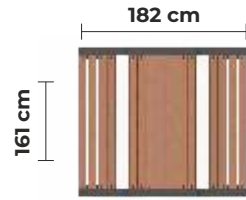

PM
40

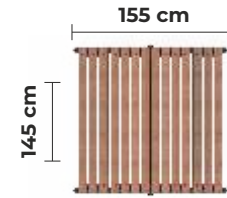

PM
38

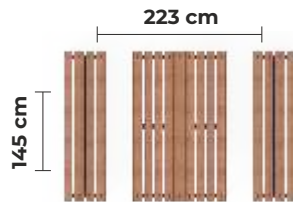

PM
41

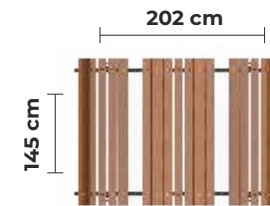

PM
39

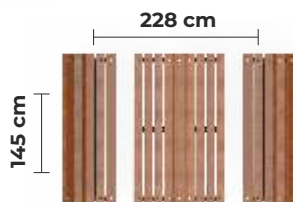

PM
42

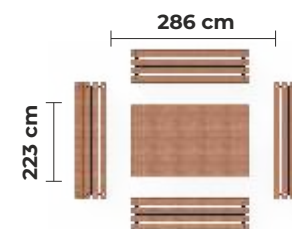

PM
43

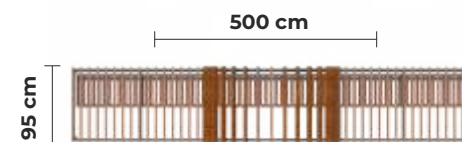

PM
44

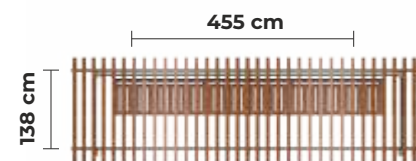

PM
45

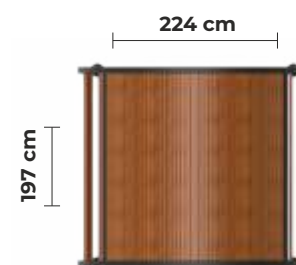

PM
46

1. Sınıf Sarı Çam
Emprenyeli



300X300 cm
400X400 cm

PM
47

1. Sınıf Sarı Çam
Emprenyeli



300X300 cm
400X400 cm

PM
48

Bisiklet Parkı
7'li



311X89 cm

PM
49

Bisiklet Parkı
5'li

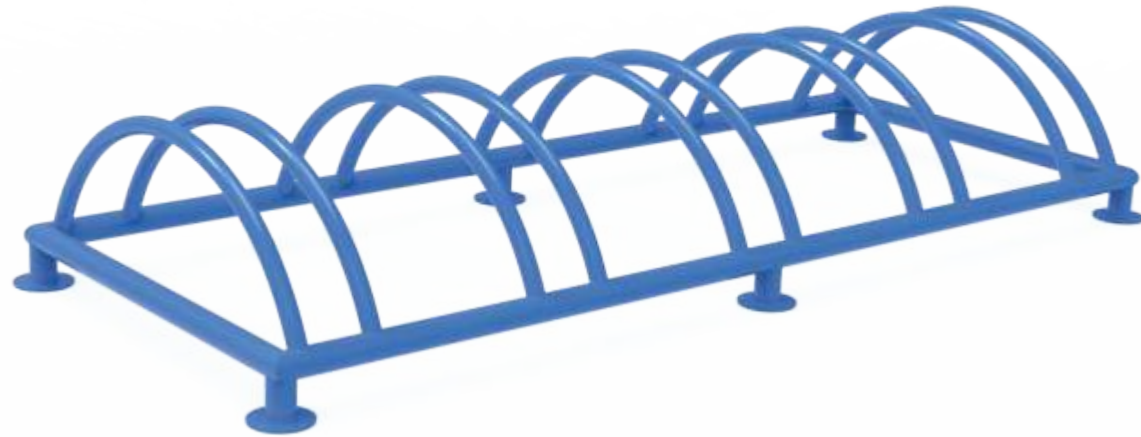

211X89 cm

A close-up photograph of a person's foot wearing a dark blue sneaker with bright yellow laces. The foot is stepping on a brown rubber track with white lane markings. The track surface is textured and appears to be made of rubber. The background is slightly blurred, showing more of the track and some green and blue markings. The overall image has a high-contrast, almost graphic quality.

Kauçuk Zemin

Rubber Flooring

PG
01

Karo Kauçuk 40x40



Kırmızı, yeşil ve gri renklerde
Kalınlıklar: 2 - 2.5 - 3 - 4 cm

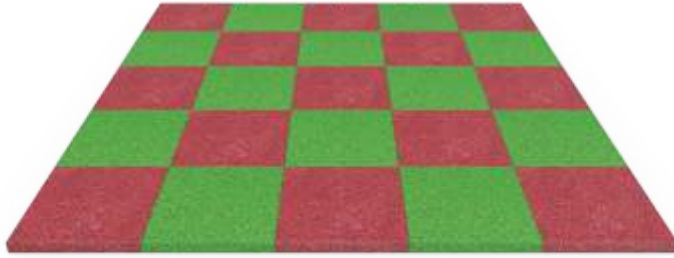

Karo Kauçuk 50x50



Kırmızı, yeşil ve gri renklerde
Kalınlıklar: 2 - 2.5 - 3 - 4 cm

Kritik Düşme Yüksekliği	Gerekli Kauçuk Kalınlığı	Kauçuk Ebadı
1,6 m	50 mm	500 x 500 mm 400 x 400 mm
2,0 m	60 mm	500 x 500 mm 400 x 400 mm
3,0 m	75 mm	500 x 500 mm 400 x 400 mm
3 + m	90 mm	500 x 500 mm 400 x 400 mm

PG
02

Puzzle Kauçuk 40x40



Kırmızı, yeşil ve gri renklerde
Kalınlıklar: 2 - 2.5 - 3 - 4 cm



Puzzle Kauçuk 50x50



Kırmızı, yeşil ve gri renklerde
Kalınlıklar: 2 - 2.5 - 3 - 4 cm

Kritik Düşme Yüksekliği	Gerekli Kauçuk Kalınlığı	Kauçuk Ebadı
1,6 m	50 mm	500 x 500 mm 400 x 400 mm
2,0 m	60 mm	500 x 500 mm 400 x 400 mm
3,0 m	75 mm	500 x 500 mm 400 x 400 mm
3 + m	90 mm	500 x 500 mm 400 x 400 mm

Altıgen Kauçuk 50x50



Kırmızı, yeşil ve gri renklerde
Kalınlıklar: 2 - 2.5 - 3 - 4 cm

Altıgen Kauçuk 40x40



Kırmızı, yeşil ve gri renklerde
Kalınlıklar: 2 - 2.5 - 3 - 4 cm



Kritik Düşme Yüksekliği	Gerekli Kauçuk Kalınlığı	Kauçuk Ebadı
1,6 m	50 mm	500 x 500 mm 400 x 400 mm
2,0 m	60 mm	500 x 500 mm 400 x 400 mm
3,0 m	75 mm	500 x 500 mm 400 x 400 mm
3 + m	90 mm	500 x 500 mm 400 x 400 mm



Dökme Kauçuk

Hem asfalt hemde beton zemine uygulanabilir. Su geçirimli, top ile oynanan bütün spor dalları ve yürüyüş yolları için uygun ve uzun ömürlü bir zemin kaplama malzemesidir.





Yedek Parça
Spare Parts

PY
01

ARABA ÇATI
CAR ROOF



PY
02

KAPLUMBAĞA ÇATI
TURTLE ROOF



PY
03

ŞİRİN ÇATI
MUSHROOM ROOF



PY
04

EV ÇATI
HOUSE ROOF



PY
08

İDEAL ÇATI
IDEAL ROOF



PY
09

KONİK ÇATI
CHONICAL ROOF



PY
07

ROKET ÇATI
ROCKET ROOF



PY
08

KİREMİT ÇATI
TILE ROOF



PY
09

TREN ÇATI
TRAIN ROOF



PY
10

KEMER ÇATI
ARCH ROOF

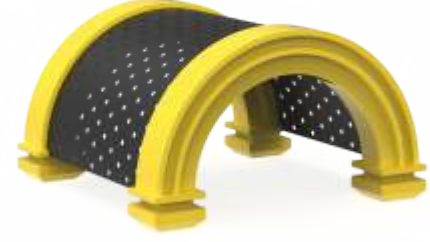

PY
11

ALTIGEN ÇATI
HEXAGONAL ROOF



PY
12

ALTIGEN PARÇALI ÇATI
HEXAGONAL PARTIAL ROOF



PY
13

H100 DALGALI KAYDIRAK
H100 WAVY SLIDE



PY
14

H100 DÜZ KAYDIRAK
H100 STRAIGHT SLIDE



PY
15

H100 SAĞA EĞİMLİ KAYDIRAK
H100 RIGHT CURVED SLIDE



PY
16

H100 SOLA EĞİMLİ KAYDIRAKÇATI
H100 LEFT CURVED SLIDE



PY
17

H100 ÇİFTLİ KAYDIRAK
H100 DOUBLE SLIDE



PY
18

H150 DÜZ KAYDIRAK
H150 STRAIGHT SLIDE



PY
19

H150 DALGALI KAYDIRAK
H150 WAVY SLIDE



PY
20

H150 DALGALI ÇİFTLİ KAYDIRAK
H150 DOUBLE WAVY SLIDE



PY
21

H200 DÜZ KAYDIRAK
H200 STRAIGHT SLIDE



PY
22

H100 - H150 - H200 PARÇALI KAYDIRAK
H100 - H150 - H200 SECTIONAL SLIDE



PY
23

H150 SPİRAL KAYDIRAK
H150 SPIRAL SLIDE



PY
24

H200 SPİRAL KAYDIRAK
H200 SPIRAL SLIDE



PY
25

H100 FİGÜRLÜ TÜP KAYDIRAK
H100 FIGURED TUBE SLIDE



PY
26

H100 TÜP KAYDIRAK
H100 TUBE SLIDE



PY
27

H150 TÜP KAYDIRAK
H150 TUBE SLIDE



PY
28

H100 FİGÜRLÜ KEDİ PANOLU TÜP KAYDIRAK
H100 FIGURED TUBE SLIDE WITH CAT PANEL



PY
29

H150 FİGÜRLÜ KEDİ PANOLU TÜP KAYDIRAK
H150 FIGURED TUBE SLIDE WITH CAT PANEL



PY
30

H150 FİGÜRLÜ TÜP KAYDIRAK
H150 FIGURED TUBE SLIDE



PY
31

H200 FİGÜRLÜ KEDİ PANOLU TÜP KAYDIRAK
H200 FIGURED TUBE SLIDE WITH CAT PANEL



PY
32

H200 FİGÜRLÜ TÜP KAYDIRAK
H200 FIGURED TUBE SLIDE



PY
33

H200 TÜP KAYDIRAK
H200 TUBE SLIDE



PY
34

H285 ŞEFFAF TÜPLÜ SİRALI KAYDIRAK
H285 SPIRAL SLIDE WITH TRANSPARENT TUBE



PY
35

H100 TÜP GEÇİT
H100 TUBE PASSING

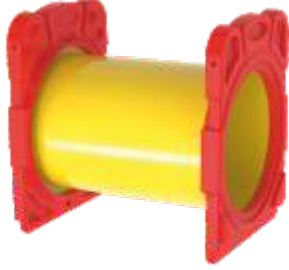

PY
36

H315 EĞİMLİ TÜP GEÇİT
H315 CURVED TUBE PASSING



PY
37

H200 FİGÜRLÜ TÜP GEÇİT
H200 FIGURED TUBE PASSING



PY
38

H260 EĞİMLİ TÜP GEÇİT
H260 CURVED TUBE PASSING



PY
39

H100 TIRTIL MERDİVEN
H100 CATERPILLAR STAIRS



PY
40

KAYA TIRMANMA
ROCK CLIMBING



Spare Parts

PY
41

KEDİ FANUS PANO
CAT PANEL WITH BELL JAR



PY
42

KEDİ & ASLAN FİĞÜRLÜ PANO
CAT & LION FIGURED PANEL



PY
43

PANO
PANEL



PY
44

KEDİ PANO
CAT PANEL



PY
45

ÖRDEK FİĞÜRLÜ PANO
DUCK FIGURED PANEL



PY
46

ASLAN FİĞÜRLÜ PANO
LION FIGURED PANEL



PY
47

FANUS PANO
BELL JAR PANEL



PY
48

FARE FİĞÜRLÜ PANO
MAUSE FIGURE PANEL



PY
49

ŞAPKA FİGÜRLÜ KAYDIRAK GİRİŞİ
HAT FIGURED SLIDE ENTRY



PY
50

AHŞAP FİGÜRLÜ KAYDIRAK GİRİŞİ
WOODEN FIGURED SLIDE ENTRY



PY
51

BUGS BUNNY SUR PANO
BUGS BUNNY SLIDE ENTRY



PY
52

SİRAL KAYDIRAK GİRİŞİ
SPIRAL SLIDE ENTRY



PY
53

KAYDIRAK GİRİŞİ
SLIDE ENTRY



PY
54

ORMAN PANO
JUNGLE PANEL



PY
55

PENCERE PANO
WINDOW PANEL



PY
56

PENCERE FİGÜRLÜ PANO
WINDOW FIGURED PANEL



Spare Parts

PY
57

ÇİT PANO
FENCE PANEL



PY
58

BUGS BUNNY ÇİT PANO
BUGS BUNNY FENCE PANEL



PY
59

KEMER
ARCH



PY
60

BANK FİĞÜRLÜ PANO
BENCH FIGURED PANEL



PY
61

AĞAÇKAKAN FİĞÜRE
WOODPECKER FIGURE



PY
62

PALMIYE
PALM TREE



PY
63

SİNCAP FİĞÜRÜ
SQUIRREL FIGURE



PY
64

BUGS BUNNY FİĞÜRÜ
BUGS BUNNY FIGURE



PY
65

ATV ZIPZIP
ATV SPRINGER



PY
66

KEDİ ZIPZIP
CAT SPRINGER



PY
67

KURBAĞA
FROG SPRINGER



PY
68

MOTOR ZIPZIP
MOTORCYCLE SPRINGER



PY
69

AT ZIPZIP
HORSE SPRINGER



PY
70

KÖPEK ZIPZIP
DOG SPRINGER



PY
71

ELCEK
HANDLE



PY
72

FİTNES ELCEK
FITNESS HANDLE



PY
73

SALINCAK OTURAĐI + KORKULUĐU
SWING SEAT AND RAIL



PY
74

ZİNCİRLİ SALINCAK TAKIMI
SWING SEAT SET WITH CHAINS



PY
75

SALINCAK KORKULUĐU
SWING RAIL



PY
76

SALINCAK OTURAĐI
SWING SET



PY
77

KULUĐKA SALINCAK OTURAĐI
BIRD NEST SWING SEAT



PY
78

ZİNCİRLİ KULUĐKA SALINCAK
BIRD NEST SWING SEAT WITH CHAINS



PY
79

ENGELSİZ OTURAĐI
DISABLED SEAT



PY
80

EBEVEYN SALINCAK OTURAĐI
PARENT AND CHILD SWING SEAT



PY
81

FIGÜRLÜ TÜP ÇIKIŞ
FIGURED TUBE EXIT



PY
82

80 CM FIGÜRLÜ TÜP
80 CM FIGURED TUBE



PY
83

90° ŞEFFAF TÜP
90° TRANSPARENT TUBE



PY
84

35° ŞEFFAF TÜP
35° TRANSPARENT TUBE



PY
85

60 CM ŞEFFAF TÜP
60 CM TRANSPARENT TUBE



PY
86

60 CM TÜP
60 CM TUBE



PY
87

80 CM TÜP
80 CM TUBE



PY
88

100 CM TÜP
100 CM TUBE



Spare Parts

PY
89

90° TÜP
90° TUBE

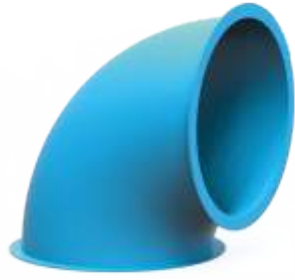

PY
90

35° TÜP
35° TUBE



PY
91

MANTAR FİĞÜRÜ
MUSHROOM FIGURE



PY
92

ATEŞ ÇEMBERİ
RING OF FIRE



PY
93

ANKRAJ KAPAĞI
ANCHORAGE COVER



PY
94

MANTAR SEKSEK
MUSHROOM HOPSCOTCH



PY
95

DİSK TIRMANMA
DISC CLIMBING PART



PY
96

ELİPS TIRMANMA
ELLIPTICAL CLIMBING PART



PY
97

Ø 89 TAHTEREVALLİ OTURAĞI
Ø 89 SEESAW SEAT



PY
98

Ø 114 TAHTEREVALLİ OTURAĞI
Ø 114 SEESAW SEAT



PY
99

KLASİK TAHTEREVALLİ OTURAĞI
CLASSICAL SEESAW SEAT



PY
100

KAYA TIRMANMA TUTAMAĞI
ROCK CLIMBING HANDLE



PY
101

Ø 89 ŞAPKA KAPAK
Ø 89 HAT PLUG



PY
102

Ø 114 ŞAPKA KAPAK
Ø 114 HAT PLUG



PY
103

VİDA GİZLEME
SCREW HIDING



PY
104

RULMAN GİZLEME
BEARING HIDING



Spare Parts

PY
105

DİK AĞIZ
STRAIGHT CONNECTION PART FOR CLAMP



PY
106

PLASTİK DİK AĞIZ KELEPÇE
PLASTIC CLAMP WITH STRAIGHT CONNECTION PART



PY
107

EĞRİ AĞIZ
CURVED CONNECTION PART



PY
108

PLASTİK EĞRİ AĞIZ KELEPÇE
PLASTIC CLAMP WITH CURVED CONNECTION PART



PY
109

RULMANLI METAL KELEPÇE
METAL CLAMP WITH BEARING



PY
110

METAL KELEPÇE
METAL CLAMP



PY
111

METAL KURTAĞZI KELEPÇE TİP 2
METAL DOETAIL CLAMP TYPE 2



PY
112

METAL KURTAĞZI KELEPÇE TİP 1
METAL DOETAIL CLAMP TYPE 1



PY
113

FİTNES OTURAK
FINESSE SEAT



PY
114

FİTNES SIRTLIK VE OTURAK
FITNESS BACKREST AND SEAT



PY
115

FİTNES AYAK DİSKİ
FITNESS FOOT DISK



PY
116

FİTNES EL DİSKİ
FITNESS HAND DISK



PY
117

FİTNES DİREKSİYON
FITNESS WHEEL



PY
118

KPY-117 FİTNES PEDAL
FITNESS PEDAL



PY
119

FİTNES ANKRAJ KAPAĞI
FITNESS ANCHORAGE COVER



PY
120

FİTNES SAĞ VE SOL AYAKLIK
FITNESS RIGHT AND LEFT STAND



PY
121

çit
FENCE



PY
122

BUGS BUNNY ÇİT
BUGS BENNY FENCE



PY
123

150 CM DÜZ KÖPRÜ VE BUGS BUNNY ÇİT KORKULUĞU
150 CM STRAIGHT BRIDGE AND BUGS BUNNY FENCE RAILS



PY
124

150 CM DÜZ KÖPRÜ VE ÇİT KORKULUĞU
150 CM STRAIGHT BRIDGE AND FENCE RAILS



PY
125

DÜZ KÖPRÜ VE KORKULUĞU
STRAIGHT BRIDGE AND RAIL



PY
126

50-100 KULDEN KULEYE RAMPA VE ÇİT KORKULUĞU
50-100 RAMP AND FENCE RAILS FROM TOWER TO TOWER



PY
127

0-50 YERDEN KULEYE RAMPA VE KORKULUĞU
0-50 RAMP AND RAILS FROM GROUND TO TOWER



PY
128

50-100 KULEDEN KULEYE RAMPA VE KORKULUĞU
50-100 RAMP AND RAIL FROM TOWER TO TOWER



PY
129

116 X 116 KARE PLATFORM
116 x 116 SQUARE PLATFORM

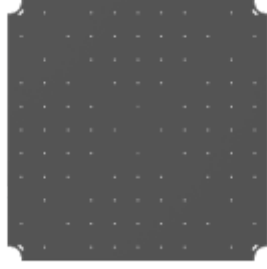

PY
130

H50 KULDEN KULEYE MERDİVEN
H50 STAIRS FROM TOWER TO TOWER



PY
131

60 X 90 SPİRAL UZATMA
60 X 90 SPIRAL SLIDE PLATFORM

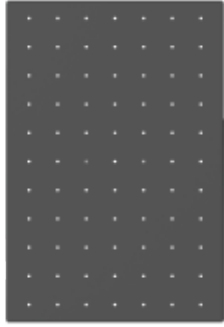

PY
132

H100 YERDEN KULEYE MERDİVEN
H100 STAIRS FROM GROUND TO TOWER



PY
133

ÜÇGEN PLATFORM
TRIANGLE PLATFORM

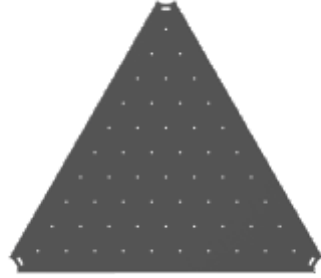

PY
134

H100 KULEDEN KULEYE MERDİVEN
H100 STAIR FROM TOWER TO TOWER



PY
135

ALTİGEN PLATFORM
HEXAGONAL PLATFORM

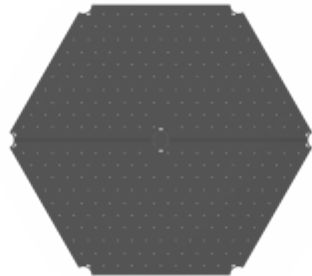

PY
136

H150 YERDEN KULEYE MERDİVEN
H150 STAIRS FROM GROUND TO TOWER



PY
137

H100 YERDEN KULEYE MERDİVEN KORKULUĞU
H100 STAIR RAILS FROM GROUND TO TOWER



PY
138

H50 KULEDEN KULEYE MERDİVEN KORKULUĞU
H50 STAIR RAILS FROM TOWER TO TOWER



PY
139

H150 YERDEN KULEYE MERDİVEN KORKULUĞU
H150 STAIR RAILS FROM GROUND TO TOWER



PY
140

H100 KULEDEN KULEYE MERDİVEN KORKULUĞU
H100 STAIR RAILS FROM TOWER TO TOWER



PY
141

H100 İÇ MERDİVEN
H100 INNER STAIRS



PY
142

H50 İÇ MERDİVEN
H50 INNER STAIRS



PY
143

SİRAL KAYDIRAK METAL KORKULUĞU
SİRAL SLIDE RAILS



PY
144

H185 İÇ MERDİVEN VE KORKULUĞU
H185 INNER STAIRS AND RAILS







**özgürce
oyna**





















**LIFE IS A HUGE
PLAYGROUND**

